

SPIRIT of PAPER®

1

04/2026

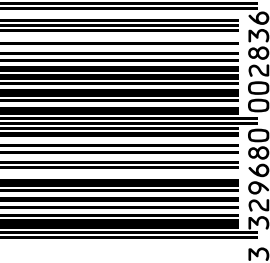

3 1329680 002836

Mai 2026

#10123

Clairefontaine
GraphicalPaper



1

SOMMAIRE



02

CLAIREFONTAINE, SPIRIT OF PAPER

UNE FAMILLE, UNE HISTOIRE	04
FABRIQUER LE PAPIER DE DEMAIN	05
YOUR PERFECT DESIGN PARTNER	07

L'ESPRIT REBECCA

Rebecca Envelopes

CROSS BRIGHT	14
EVERPRINT PREMIUM WHITE	15
ROUGH ORIGINAL	16
ROUGH NATURAL	16
EMPIRE LAID EXTRA WHITE	16
EMPIRE LAID IVORY	16
DECKLE EDGES	17

Rebecca Cross

OFFSET • LASER • INKJET	CROSS BRIGHT	22
-------------------------	--------------	----

Rebecca Rock

OFFSET • LASER • INKJET	BRUT BRIGHT	32
OFFSET • LASER • INKJET	ROUGH BRIGHT	36
HP INDIGO • OFFSET • LASER	INDIGO BRIGHT	40
OFFSET • LASER • INKJET	SILK BRIGHT	44
OFFSET • LASER • INKJET	BRUT ORIGINAL	48
OFFSET • LASER • INKJET	ROUGH ORIGINAL	52
HP INDIGO • OFFSET • LASER	INDIGO ORIGINAL	58
OFFSET • LASER • INKJET	SILK ORIGINAL	62
OFFSET • LASER • INKJET	BRUT NATURAL WHITE	66
OFFSET • LASER • INKJET	ROUGH NATURAL WHITE	70
OFFSET • LASER • INKJET	BRUT NATURAL	74
OFFSET • LASER • INKJET	ROUGH NATURAL	78
OFFSET • LASER • INKJET	SILK NATURAL	82

À RETROUVER DANS LE TOME 2 :



Rebecca Life

EVERBULK PREMIUM WHITE 1.5
EVERPRINT PREMIUM WHITE
EVERSATIN PREMIUM WHITE
EVERPRINT WHITE
EVERPRINT WHITE LIGHT COATED

Rebecca Thin

C-OPAK
SMART-PRINT

Rebecca Color

GENYOU® WHITE
GENYOU® BLACK INTENSE
TROPHÉE / PAPAGO
TROPHÉE NEON
BENGALI

Rebecca Studio

SAUVAGE
TRADITION WHITE
HERITAGE WHITE
HERITAGE NATURAL WHITE
EMPIRE LAID EXTRA WHITE / IVORY
VALORISE WHITE
VALORISE NATURAL
VALORISE IVORY
ECO KRAFT BOULEAU / ECRU / MUSCAT
DECKLE EDGES

Rebecca High Speed Inkjet

ICY ORIGINAL
CLAIRJET 400 BRIGHT
CLAIRJET 400 SMOOTH
EVERJET PREMIUM

2 SOMMAIRE

Imprimé sur : couverture DCP 250g/m² - pages intérieures DCP 80g/m²



Rebecca Bulk

OFFSET • LASER • INKJET	CLAIRBOOK 1.5 EXTRA WHITE	88
OFFSET • LASER • INKJET	CLAIRBOOK 1.5 / 1.8 / 2.0 NATURAL WHITE	92
OFFSET • LASER • INKJET	CLAIRBOOK 1.5 / 1.8 / 2.0 IVORY	96

Fabrications en formats possibles jusqu'à 800 g/m²
pour l'ensemble de la gamme des papiers.

Manufacturing in sheets available up to 800 gsm
for the entire range of papers.

Rebecca Sublim

OFFSET • LASER	SUBLIM BRIGHT	102
OFFSET • LASER	LIFE SUBLIM	106

Découvrez nos produits certifiés FSC® dans ce catalogue.

UNE FAMILLE, UNE HISTOIRE

ONE STORY, ONE FAMILY

Les Papeteries de Clairefontaine tiennent leur ADN d'un homme, Charles Nusse (1901-1983), qui incarne presque l'histoire du papier à lui seul.

Arrière-petit-fils de Jean-Michel Bichelberger - fondateur des Papeteries de Clairefontaine il y a un siècle et demi (1858) - il impose une ligne faite de conviction - produire des papiers de qualité - et d'intuition - utiliser de nouveaux outils pour conquérir un public. Une excellente maîtrise de l'ingénierie et une redoutable connaissance du marché s'affirment par la suite comme les deux fers de lance de la marque.

Cette ligne forte, il la transmet à l'un de ses fils, Jean-Marie Nusse qui, pendant cinq décennies, forgera la réputation de Clairefontaine. Aujourd'hui, c'est à son petit-fils Frédéric Nusse qu'il revient de poursuivre ce legs avec la même passion que celle de ses prédécesseurs.

Papeteries de Clairefontaine got their DNA from one man, Charles Nusse (1901-1983).

Charles Nusse represents almost solely the History of Paper: Great-grandson of Jean-Michel Bichelberger - founder of Papeteries de Clairefontaine half a century ago (1858) - he imposed a line made of conviction - to produce quality papers with intuition and foresight - to use new tools to conquer an audience. Excellent engineering skills and a formidable knowledge of the market later became the spearheads of the Clairefontaine brand.

He passed on this strong line to one of his sons, Jean-Marie Nusse, who for five decades will forge Clairefontaine's reputation. Today, it is up to one of his grandsons: Frédéric Nusse to continue this legacy with the same passion as his predecessors.



Charles Nusse 1950, Papeteries de Clairefontaine Etival.

FABRIQUER LE PAPIER DE DEMAIN

MAKING THE PAPER FOR TOMORROW

Laissons parler les chiffres.

Chaque année, à Clairefontaine dans les Vosges en France, berceau de l'entreprise, 330 000 palettes de papiers certifiés FSC® ou PEFC sont expédiées partout en Europe.

À cette force première, trois autres sites externes apportent chacun une valeur ajoutée. La Papeterie de Mandeuve dans le Doubs, forte d'une histoire commencée en 1871, maîtrise la fabrication d'une carte 100% cellulose, en monojet, avec des grammages qui varient de 100 à 600 g/m².

Aux Pays-Bas, l'usine de Schut Papier (1618) apporte avec elle quatre siècles de savoir-faire dans les domaines des papiers spéciaux et Beaux Arts.

En 1994, l'usine d'Everbal en région Champagne a consolidé cette structure. Plus qu'une acquisition, Everbal concrétise un projet ambitieux, la fabrication de papiers recyclés. Usine fonctionnant à l'énergie biomasse, son empreinte carbone ambitionne d'être la plus réduite possible (proche de zéro). La pérennité des Papeteries de Clairefontaine s'adosse enfin à la force du groupe Exacompta Clairefontaine, groupe européen, coté en bourse, leader pour les produits de classement et la papeterie de bureau.

Let our numbers speak for themselves.

Every year, at Clairefontaine in the Vosges, France, the birthplace of the company, 330 000 pallets of FSC® or PEFC certified paper are despatched throughout Europe.

In addition to this primary strength, three other external sites each bring added value. Papeterie de Mandeuve in the Doubs, with a history that began in 1871, masters the manufacture of 100% cellulose cardboard, in single-jet, with substances that vary from 100 to 600 gsm. The Schut Papier factory in the Netherlands (1618) brings four centuries of know-how in the fields of speciality and Fine Arts papers.

In 1994, the Everbal mill in the Champagne region consolidated this structure. Better than an addition, Everbal carries out an ambitious project, the manufacture of recycled papers. With its biomass-powered plant, its carbon footprint aims to be as low as possible (close to zero).

The long-term future of Papeteries de Clairefontaine is backed up by the power of Exacompta Clairefontaine, a European group listed on the stock exchange and a leader in filing products and office stationery.

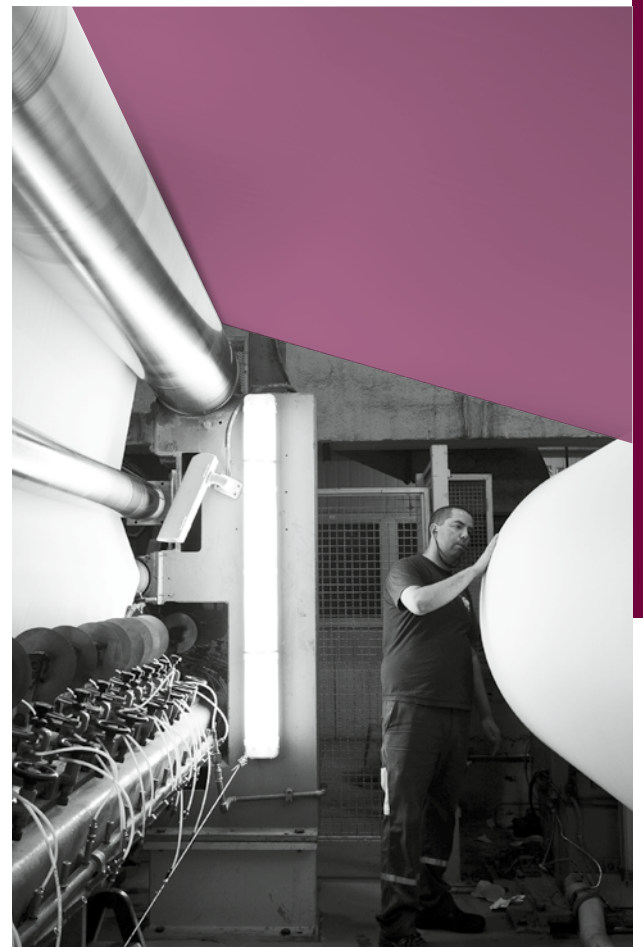

Bobineuse, Papeteries de Clairefontaine Etival.



CONTACTS

Do not hesitate to contact your dedicated key account manager:

France:

Emmanuelle HUBERT: +33 6 80 51 75 84 • emmanuelle.hubert@clairefontaine.eu

Jean-Marc DUBOIS: +33 6 21 98 22 46 • jean-marc.dubois@clairefontaine.eu

Germany / Switzerland / Austria / Eastern Europe / Scandinavia:

Ansgar REINERS: +49 1 736 985 267 • ansgar.reiners@clairefontaine.eu

Axel FREVERT: +49 1 742 126 788 • axel.frevert@clairefontaine.eu

Rainer KOPISCHKE: +49 1 704 873 286 • rainer.kopischke@clairefontaine.eu

Benelux:

Laurent HEESTERBEEK: +32 460 971 432 • laurent.heesterbeek@clairefontaine.eu

Central Europe / Baltic:

Andréas FRANZOLINI: +33 750 060 213 • andreas.franzolini@clairefontaine.eu

Italia:

Simone MEDICI: +39 3 387 279 185 • simone.medici@clairefontaine.eu

United Kingdom:

Dean GLEW: +44 7 355 629 346 • dean.glew@clairefontaine.eu

Envelopes Department:

Laetitia SCHIRR: +33 3 29 27 20 97 • contact-enveloppes@clairefontaine.eu

Qu'est-ce qu'un beau papier ?

Qu'est-ce qu'une belle impression ?

À ces deux questions, Clairefontaine répond avec la même compétence. Un « beau papier », cela signifie une esthétique, une main, un rapport à la matière qui crée un lien, incarne la substance d'un projet. Une « belle impression », c'est un papier efficace qui pour l'imprimeur donnera contraste, brillance, uniformité, supportera Pantone, fer à dorer, vernis. Toute la notoriété des papiers Clairefontaine s'exprime dans ces supports non couchés, haut de gamme et tous certifiés FSC®. La parfaite maîtrise de leur production garantit une impression sans écueils. Profondeur et couleurs ne souffrent d'aucune altération.

Clairefontaine destine ses gammes graphiques aux imprimeurs, aux designers, aux éditeurs, aux agences de communication, aux "créateurs fous et culottés", au monde vaste de l'impression, de la création et de l'édition, à celles et ceux qui recherchent un support haut de gamme pour affirmer une idée, un concept.

Pour tous ces professionnels, Clairefontaine propose des papiers graphiques à la hauteur de leur ambition au sein de neuf gammes : Rebecca Cross - Rebecca Rock - Rebecca Bulk - Rebecca Sublim - Rebecca Life - Rebecca Studio - Rebecca Thin - Rebecca High Speed Inkjet - Rebecca Color.

What is a beautiful paper?

What is a beautiful print?

Clairefontaine answers these two questions with the same competence. A «beautiful paper» means an aesthetic relationship with bulk that creates a bond, which embodies the material of a project. A «beautiful print» is an effective paper that for the printer, will give contrast, brilliance and uniformity, will support all Pantones, gold dust and varnish.

All the authority of Clairefontaine papers is expressed in these uncoated, top-of-the-range FSC® and ECF certified uncoated papers. The Operational Excellence of the manufacturing process avoids the printing pitfalls. Depth and colours do not suffer any alteration.

Clairefontaine's graphic ranges are aimed at printers, designers, publishers, communication agencies, audacious and creative strategists, the vast world of printing, creation and publishing, and those looking for a top-of-the-range medium to assert an idea or a concept.

For them Clairefontaine offers graphic papers which match their ambition in nine ranges: Rebecca Cross - Rebecca Rock - Rebecca Bulk - Rebecca Sublim - Rebecca Life - Rebecca Studio - Rebecca Thin - Rebecca High Speed Inkjet - Rebecca Color.

YOUR PERFECT DESIGN PARTNER

YOUR PERFECT DESIGN PARTNER



L'ESPRIT REBECCA

REBECCA SPIRIT



Trois mots définissent nos gammes :

expertise, esthétique, efficacité.

Nos papiers graphiques reçoivent tout notre savoir-faire, toute notre expertise en matière de traitement de surface. Nous avons pour ambition qu'ils répondent sans failles à un degré d'exigence élevé afin de former un support parfait. Enfin, ils se doivent d'être d'une machinabilité optimale pour les imprimeurs.

Ces gammes incarnent notre idée d'un papier graphique, son esprit.

En hommage au logo de notre marque, nous les avons baptisés Rebecca, du nom de cette figure féminine et bienveillante du livre de la Genèse qui accompagne l'histoire de Clairefontaine.

Three words define our ranges:

expertise, excellence, efficiency.

Our graphic papers have received all our know-how, all our expertise in surface treatment. Our ambition is that they meet a high level of requirements without fail in order to form a perfect medium. Finally, they must be of optimum runnability for printers.

These ranges exemplify our idea of a graphic paper, its spirit.

As a tribute to our brand logo, we have named the range Rebecca, after the feminine and benevolent figure from the Book of Genesis that accompanies the history of Clairefontaine.

Rebecca Cross

L'OUTIL DE TOUTES VOS ENVIES

Quel meilleur outil que celui qui peut répondre vite et bien aux utilisations les plus nombreuses ?

Rebecca Cross a été conçue dans ce but. Couteau suisse de nos gammes, son domaine d'application couvre aussi bien les documents transactionnels, les brochures que les livres. Les graphistes pourront composer aisément en couleurs comme en noir et blanc leurs créations que l'impression respectera à la lettre.

THE TOOL OF ALL YOUR DESIRES

What better tool than the one that can quickly and perfectly respond to the most numerous uses?

Rebecca Cross was designed with this in mind. As the Swiss Army Knife from our range, its field of application covers transactional documents, brochures and books. Graphic designers will be able to easily compose in colour as well as in black and white creations that the printing will strictly respect.

Rebecca Rock

LA CRÉATION SANS LIMITE

Choisir la gamme Rebecca Rock, c'est choisir un papier qui est, avant tout, une prouesse technique.

Audacieux, son toucher rugueux n'entame en rien son imprimabilité. Cette performance associée à une blancheur élevée le rendent particulièrement adapté à des créations de marketing direct.

CREATION WITHOUT LIMITS

Choosing the Rebecca Rock range means choosing a paper that is, above all, a technical feat.

Bold, its rough touch does not detract from its printability.

This performance combined with a high whiteness makes it particularly suitable for direct marketing creations.



L'ESPRIT REBECCA

REBECCA SPIRIT



10

Rebecca Bulk

UN CHALLENGER OPTIMUM

La gamme Bulk c'est d'abord un papier bouffant idéal pour les livres tirés en petite comme en grandes séries.

Sa main assure une tenue irréprochable. Son opacité et sa régularité témoignent de sa réussite. Il a été pensé pour la presse numérique - laser ou jet d'encre - comme pour la rotative offset.

AN OPTIMUM CHALLENGER

The Bulk range is first of all an ideal, bulky paper for books printed in small or large quantities.

Its bulk ensures a perfect hold. Its opacity and regularity testify to its success. It has been designed for the digital press - laser or inkjet - as well as for the web offset press.

Rebecca Sublim

LE HAUT DE GAMME ÉDITORIAL

Sublim offre une redoutable alternative aux papiers couchés !

La gamme Rebecca Sublim assure pour le monde de l'illustré un rendu parfait, sans images enterrées. Pour l'imprimeur c'est la certitude d'une impression sans bavure, la possibilité d'utiliser une gamme de traitements variés, de travailler l'éclat et la blancheur. Pour l'agence de communication, c'est un catalogue dont le blanc pur est idéal pour les livrets ou le monde du luxe.

TOP OF THE RANGE FOR EDITION

Sublim offers a formidable alternative to coated papers!

The Rebecca Sublim range provides the world of illustration with a perfect rendering, without blurred images. For the printer, it is a warranty of a neat printing, four-colour or offset process, the possibility to use a range of different treatments to work on brightness and whiteness. For the communication agency, it is a catalogue where a pure white is ideal for booklets or the world of luxury goods.

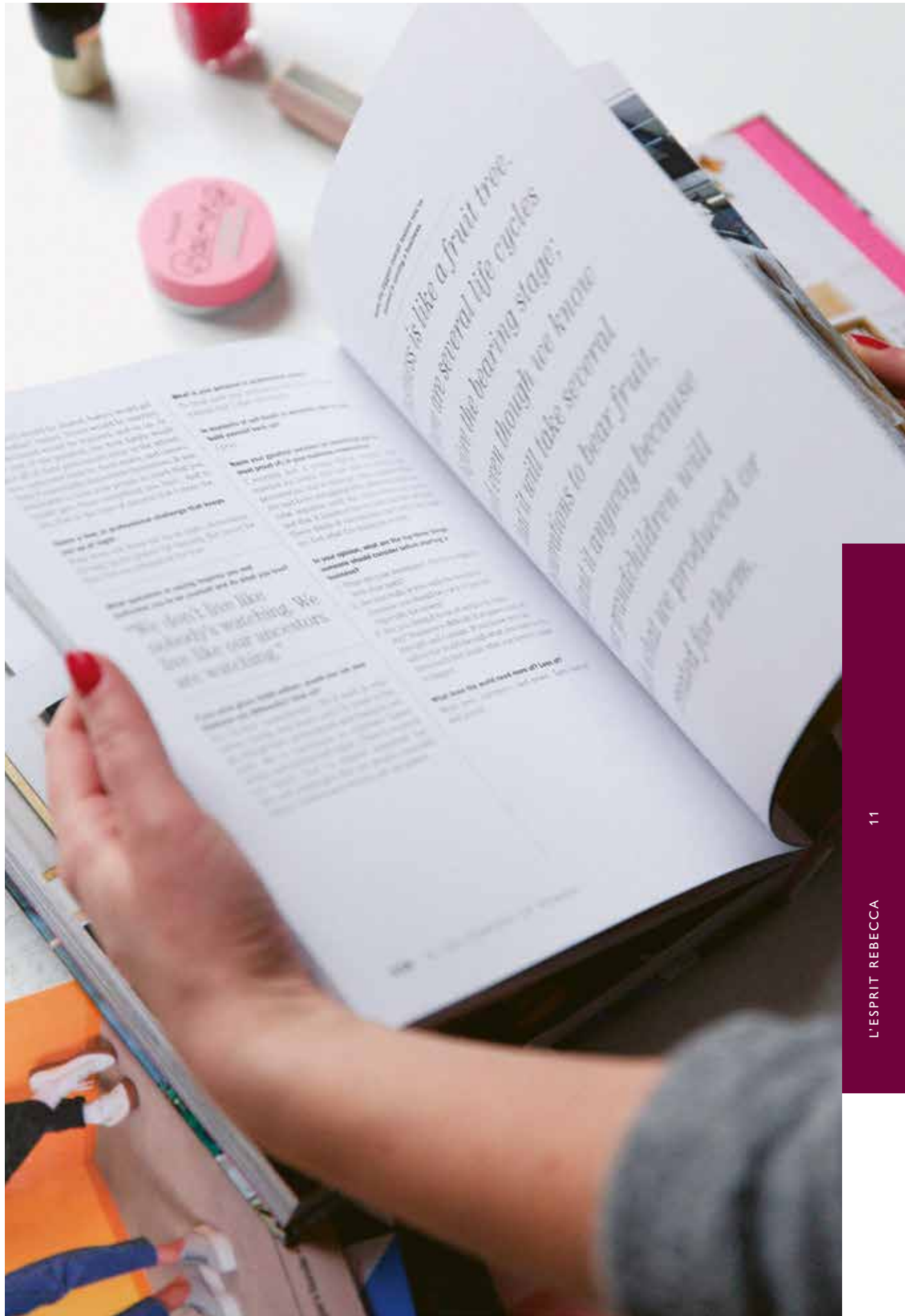

STOCKED ENVELOPES

FORMATS STANDARD

STANDARD FORMATS AVAILABLE

C6 - 114x162mm



DL - 110x220mm



Window : 35x100

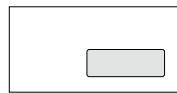

Window : 45x100

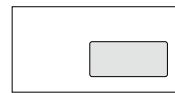

Window : 45x90

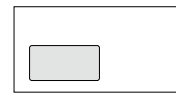

C6/5 - 114x229mm

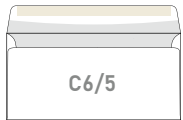

Window : 40x110

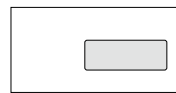

C5 - 162x229mm

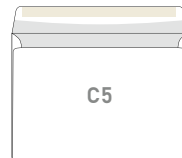

Window : 45x100

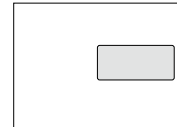

C6/5 - 114x229mm

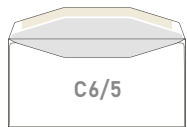

Window : 35x100

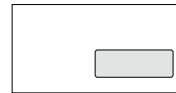

Window : 45x100

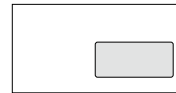

C5 - 162x229mm

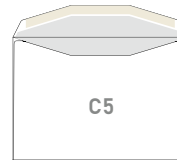

Window : 45x100

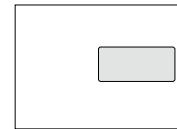

C4 - 229x324mm

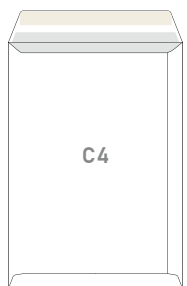

Window : 50x100

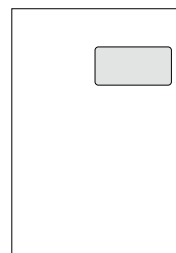

Window : 55x90

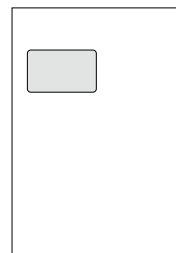

GAMME D'ENVELOPPES

POUR ACCOMPAGNER NOS PAPIERS GRAPHIQUES

ENVELOPPES RANGE

TO MATCH OUR GRAPHICAL PAPERS

Et si l'enveloppe s'intégrait naturellement à votre support de communication ?

A côté de leurs machines à papier, Les Papeteries de Clairefontaine disposent d'un atelier de fabrication d'enveloppes. C'est donc tout naturellement que Clairefontaine vous propose de vous accompagner dans vos envois. Fabriquées à partir des papiers graphiques, Cross, Rock, Bulk, Satin, Sublim, Life ou Studio, les enveloppes graphiques peuvent être déclinées en plusieurs teintes, textures et formats pour s'harmoniser parfaitement à vos documents imprimés. Elles offrent une parfaite harmonie entre finition élégante, toucher raffiné et rendu haut de gamme. Idéales pour la correspondance professionnelle, les envois institutionnels ou les supports de communication créatifs, elles assurent une continuité visuelle et tactile avec vos papiers, ou comment affirmer votre patte, jusque dans le moindre détail !

What if the envelope were to blend in naturally with your communication support?

Alongside their paper machines, Les Papeteries de Clairefontaine also have an envelope manufacturing workshop. That is why we are here to help with your mailings. Made from Cross, Rock, Bulk, Sublim, Life or Studio graphic papers, graphic envelopes come in a range of shades, textures and sizes to match your printed documents perfectly. They offer a combination of elegant finish, refined feel and top-of-the-range rendering. Ideal for business correspondence, corporate mail, or creative communications, they ensure visual and tactile continuity with your paper; so you can make your mark, right down to the smallest detail!



STOCKED ENVELOPES 80 - 90 gsm

CROSS BRIGHT - ADHESIVE ENVELOPES / POCKETS Paper Range Cf. TOME 1 - page 20

Ref.	Sizes (mm)	Gsm	Flap	Window	Units / Box	Box / Weight (kg)	Pallet Sizes (mm)	Units / Pallet	Pallet Net Weight (kg)
1431C	C6 - 114 x 162	80	adhesive	∅	500	1,65	120 x 80	98	162
1400C	DL - 110 x 220	80	adhesive	∅	500	2,20	120 x 80	104	230
1600C	DL - 110 x 220	90	adhesive	∅	250	1,40	120 x 80	198	278
1401C	DL - 110 x 220	80	adhesive	35x100 (20/20)	500	2,20	120 x 80	104	230
1601C	DL - 110 x 220	90	adhesive	35x100 (20/20)	250	1,40	120 x 80	198	278
1402C	DL - 110 x 220	80	adhesive	45x100 (20/20)	500	2,20	120 x 80	104	230
1603C	DL - 110 x 220	80	adhesive	45x100 (20/20)	250	1,40	120 x 80	198	278
1403C	DL - 110 x 220	80	adhesive	45x90 (15/20)	500	2,20	120 x 80	104	230
1429C	C6/5 - 114 x 229	80	adhesive	∅	500	2,40	120 x 80	96	230
1430C	C6/5 - 114 x 229	80	adhesive	40x110 (30/20)	500	2,60	120 x 80	96	230
1604SC	C5 - 162 x 229	90	adhesive	∅	250	2,15	120 x 80	120	258
1605C	C5 - 162 x 229	90	adhesive	45x100 (62/20)	250	2,15	120 x 80	120	258
1410C	C4 - 229 x 324	90	adhesive	∅	250	3,80	120 x 80	56	251
1411C	C4 - 229 x 324	90	adhesive	50x100 (50/20)	250	3,70	120 x 80	56	245
1412C	C4 - 229 x 324	90	adhesive	55x90 (55/20)	250	3,70	120 x 80	56	245

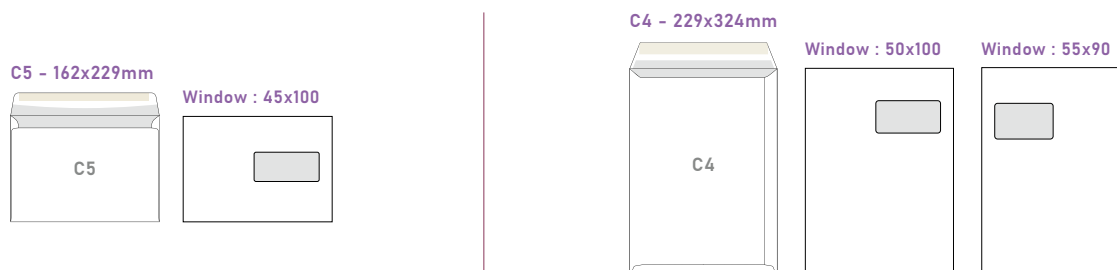

STOCKED ENVELOPES 80 gsm

CROSS BRIGHT - GUMMED ENVELOPES Paper Range Cf. TOME 1 - page 20

Ref.	Sizes (mm)	Gsm	Flap	Window	Units / Box	Box / Weight (kg)	Pallet Sizes (mm)	Units / Pallet	Pallet Net Weight (kg)
1457C	C6/5 - 114 x 229	80	gummed	∅	500	2,49	120 x 80	96	230
1458C	C6/5 - 114 x 229	80	gummed	35x100 (20/20)	500	2,45	120 x 80	96	230
1459C	C6/5 - 114 x 229	80	gummed	45x100 (20/20)	500	2,45	120 x 80	96	230
1460C	C5 - 162 x 229	80	gummed	∅	500	3,48	120 x 80	104	230
1464C	C5 - 162 x 229	80	gummed	45x100 (62/20)	500	3,46	120 x 80	104	230

C6/5 - 114x229mm

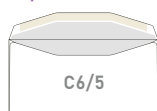

Window : 35x100

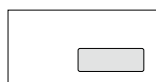

Window : 45x100

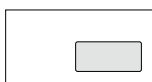

C5 - 162x229mm

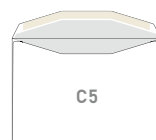

Window : 45x100

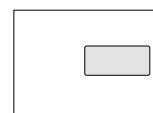

EVERPRINT PREMIUM WHITE - ADHESIVE RECYCLED ENVELOPES Paper Range Cf. TOME 2 - page 16

Ref.	Sizes (mm)	Gsm	Flap	Window	Units / Box	Box / Weight (kg)	Pallet Sizes (mm)	Units / Pallet	Pallet Net Weight (kg)
1450C	DL - 110 x 220	80	adhesive	∅	500	2,35	120 x 80	104	244
1451C	DL - 110 x 220	80	adhesive	35x100 (20/20)	500	2,40	120 x 80	104	250
1452C	DL - 110 x 220	80	adhesive	45x100 (20/20)	500	2,40	120 x 80	104	250
1453C	C5 - 162 x 229	80	adhesive	∅	500	3,48	120 x 80	66	210
1454C	C5 - 162 x 229	80	adhesive	45x100 (62/20)	500	3,48	120 x 80	66	210

DL - 110x220mm



Window : 35x100

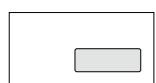

Window : 45x100

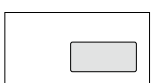

C5 - 162x229mm

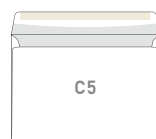

Window : 45x100

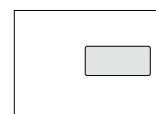

ROUGH ORIGINAL - ADHESIVE ENVELOPES Paper Range Cf. TOME 1 - page 50

Ref.	Sizes (mm)	Gsm	Flap	Window	Units / Box	Box / Weight (kg)	Pallet Sizes (mm)	Units / Pallet	Pallet Net Weight (kg)
1482C	DL - 110 x 220	115	adhesive	∅	500	3,65	120 x 80	90	341
1483C	C5 - 162 x 229	115	adhesive	∅	250	2,75	120 x 80	90	260

ROUGH NATURAL - ADHESIVE ENVELOPES Paper Range Cf. TOME 1 - page 76

Ref.	Sizes (mm)	Gsm	Flap	Window	Units / Box	Box / Weight (kg)	Pallet Sizes (mm)	Units / Pallet	Pallet Net Weight (kg)
1484C	DL - 110 x 220	120	adhesive	∅	500	3,65	120 x 80	90	341
1485C	C5 - 162 x 229	120	adhesive	∅	250	2,75	120 x 80	90	260

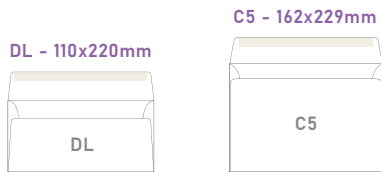

EMPIRE LAID EXTRA WHITE - ADHESIVE ENVELOPES Paper Range Cf. TOME 2 - page 54

Ref.	Sizes (mm)	Gsm	Flap	Window	Units / Box	Box / Weight (kg)	Pallet Sizes (mm)	Units / Pallet	Pallet Net Weight (kg)
4683C	DL - 110 x 220	120	adhesive	∅	250	1,83	120 x 80	135	260
4693C	C5 - 162 x 229	120	adhesive	∅	250	2,75	120 x 80	90	260

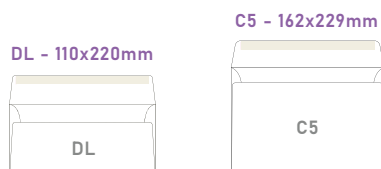

EMPIRE LAID IVORY - ADHESIVE ENVELOPES Paper Range Cf. TOME 2 - page 54

Ref.	Sizes (mm)	Gsm	Flap	Window	Units / Box	Box / Weight (kg)	Pallet Sizes (mm)	Units / Pallet	Pallet Net Weight (kg)
4687C	DL - 110 x 220	120	adhesive	∅	250	1,83	120 x 80	135	260
4697C	C5 - 162 x 229	120	adhesive	∅	250	2,75	120 x 80	90	260

STOCKED ENVELOPES **130 gsm**

DECKLES EDGES - ENVELOPES Paper Range Cf. TOME 2 - page 74

Ref.	Sizes (mm)	Gsm	Flap	Window	Units / Box
E3107C91098.0130	90 x 140	130	gummed	Ø	500
E3107C91095.0130	102 x 145	130	gummed	Ø	500
E3107C91110.0130	110 x 170	130	gummed	Ø	500
E3107C91102.0130	120 x 184	130	not gummed	Ø	500
E3107C91073.0130	120 x 184	130	gummed	Ø	500
E3107C91096.0130	140 x 140	130	gummed	Ø	500
E3107C91117.0130	146 x 200	130	gummed	Ø	500
E3107C91129.0130	160 x 160	130	gummed	Ø	500
E3107C91116.0130	165 x 208	130	gummed	Ø	500

POSSIBILITY OF MANUFACTURED ENVELOPES

LE FORMAT DONT VOUS AVEZ BESOIN THE SIZE YOU NEED

Exemples :
examples:

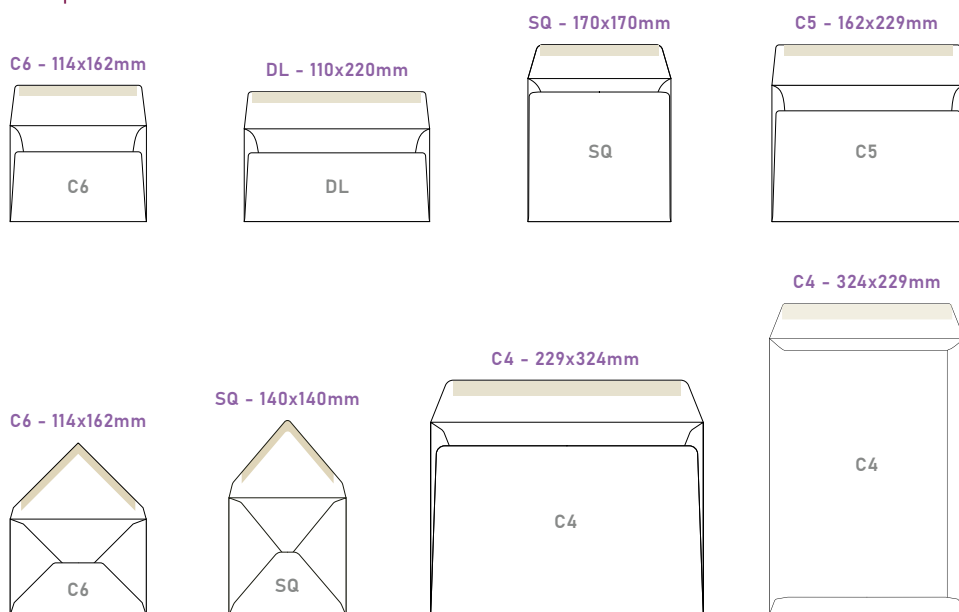

RÉALISABLE À PARTIR DE TOUS LES PAPIERS SPIRIT OF PAPER CAN BE MADE FROM ALL SPIRIT OF PAPER PAPERS

- Choisissez votre papier et votre grammage.
Choose your paper and your weight.
- Quantité mini 5 000 enveloppes.
Minimum quantity 5 000 envelopes.
- Délai de fabrication sous 2 mois maxi, à la validation des informations.
Lead time: up to 2 months from confirmation of details.
- Impression personnalisée possible.
Personalised printing available.
- Pour tout besoin particulier, nous contacter.
Notre équipe est à votre disposition : contact-enveloppes@clairefontaine.eu - Laëtitia Schirr
For any special requirements, please get in touch.
Our team remains at your disposal: contact-enveloppes@clairefontaine.eu – Laëtitia Schirr

CROSS BRIGHT



REBECCA Cross

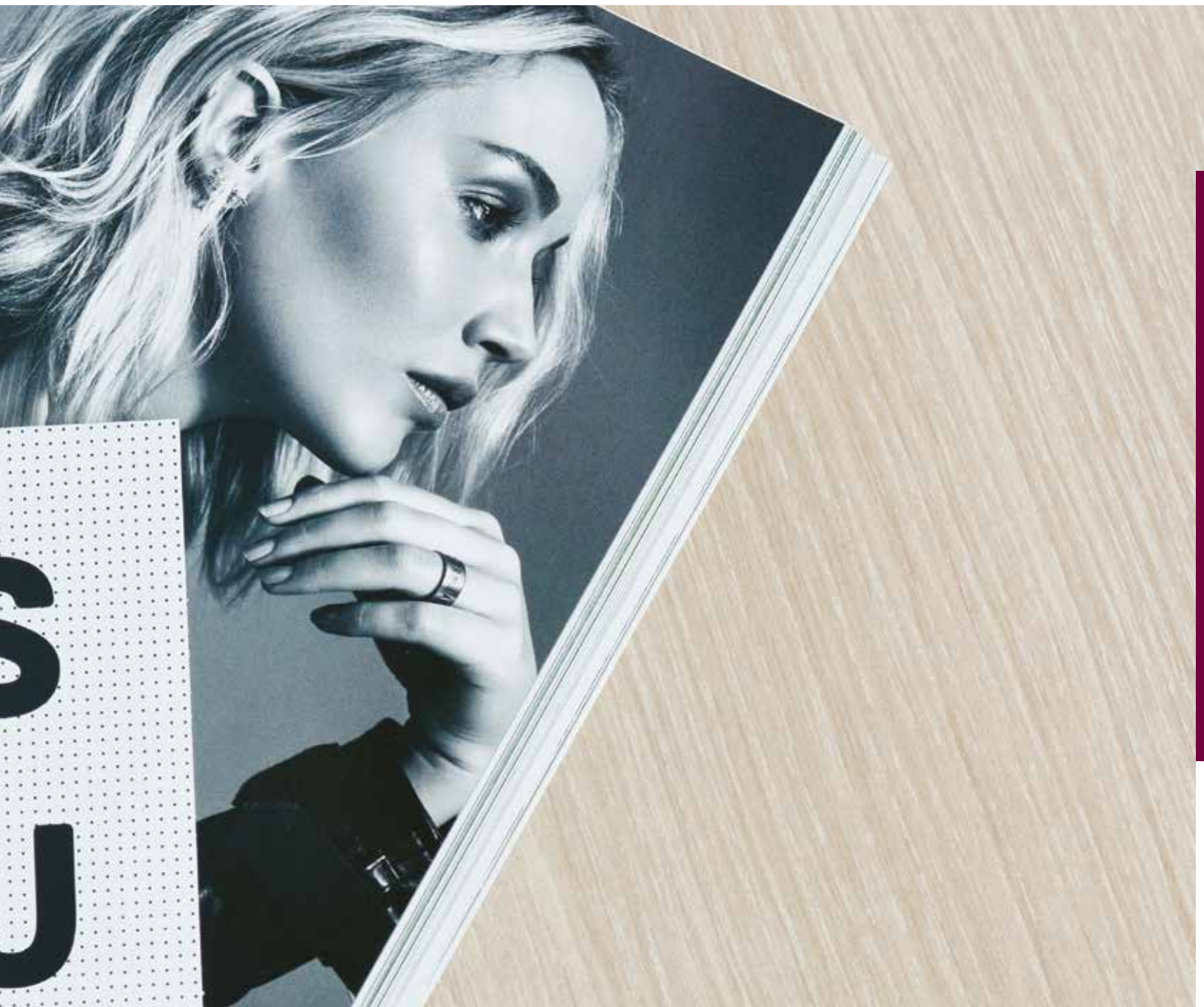

CROSS BRIGHT



FICHE TECHNIQUE / code 155/154/533 TECHNICAL DATA SHEET

	50	60	70	80	90	100	110	120	160	200	240	300	350	400
Thickness (µm)	69	83	97	108	122	134	147	156	208	260	305	375	459	518
Bulk (cm ³ /g)	1.38	1.38	1.35	1.35	1.36	1.34	1.34	1.30	1.30	1.30	1.27	1.25	1.25	1.25
Bendtsen Roughness (ml/min)	220	220	180	180	180	180	180	180	180	180	180	180	240	240
Absolute Humidity (%H ₂ O)	4.5	4.8	5.0	5.0	5.0	5.0	5.0	5.5	5.5	5.5	5.5	6.5	7.0	7.0
Relative Humidity (% in the air)	30	35	38	38	38	38	38	44	44	44	44	50	60	60
Opacity (%)	85	87.5	91	93.5	95.5	97	97	97.5	>99	>99	>99	>99	>99	>99

GAMME RANGE

	50	60	70	80	90	100	110	120	160	200	240	300	350	400
450 x 320 mm				2897C	2898C									
450 x 320 mm	1934C	1937C		4532C	2891SC	1956SC		1958C	1957C	1962C	1964C (250g)	1961C	1985C	
430 x 610 mm			3963C	4300C										
430 x 610 mm			3965C											
440 x 630 mm				3964C	2834C									
440 x 630 mm				3966C										
450 x 640 mm	2818SC	2823SC		4500C	2808SC	2828C		2829C	2822SC	2825SC	2826C			
450 x 640 mm		3996SC		4564C	2806C	2824SC		2836SC	3967C	2837SC	2838C			
460 x 640 mm		3941C	3942C	3931C	3932C	3933C		3934C	3935C	3936C	3937C			
630 x 880 mm	2856C			2812C										
880 x 630 mm	2857C	2858C	3912C	8863C	2802C	3914C		2815C	2830C					
880 x 630 mm			3968C	3969C	3994C			2839SC	3995C					
635 x 900 mm				6011C	6012C	6016C		6017C	6018C					
900 x 635 mm				6019C	6020C	6023C		6024C	6025C					
640 x 460 mm						3938C		3939C	3940C					
650 x 920 mm	2819SC			6500C	2809C		2821SC	3943C	3944C	2860C	2861C			
650 x 920 mm				6592C	2807C									
920 x 650 mm				3822C	3823C	3945C		3946C	3947C	2862C	2865C			
700 x 1000 mm			2842C	3948C	3949C	3950C		3951C	3952C	3953C	3954C	2851C		2853C
700 x 1000 mm											3890C	3891C		3892C
1000 x 700 mm				2811C	3955C	3956C		3957C	3958C	3959C	3960C	2852C	3929C	2854C
1000 x 700 mm											3893C	3894C		3895C

STOCKED ENVELOPES

CF. Page 27-28



168 CIE



ROUGHNESS

CROSS BRIGHT

REBECCA Cross

Une polyvalence sans faille.

Cross est le papier offset non-couché, idéal pour l'impression tous formats. Réputé pour son épaisseur exceptionnelle ainsi que sa main élevée, sa blancheur extrême offre les contrastes nécessaires au meilleur rendu d'impression.

Grâce à sa rigidité maximale, sa parfaite régularité de volume et sa très bonne stabilité dimensionnelle, il vous assure d'excellentes caractéristiques d'imprimabilité et de machinabilité. Ce papier est garanti pour post-impression personnalisée laser et jet d'encre. Cross existe dans un très large spectre de grammages, ce qui convient à toutes les applications.

Disponible de 50 g/m² à 400 g/m².

Cross se complète également avec les gammes Clairalfa et Smart Print en A4 et A3 de 50 g/m² à 350 g/m².

Domaines d'utilisation : têtes de lettre, factures, reçus, formulaires et documents, brochures d'entreprise, prospectus, mailings personnalisés, modes d'emploi, dépliants publicitaires, livres, rapports d'activité, fournitures de bureau, catalogues, cartes de visite.

A seamless versatility.

Cross is the ideal, uncoated white offset paper for printing in all sizes. Renowned for its exceptional formation and its high bulk, its extreme whiteness provides the necessary contrasts for the best printing results.

Thanks to its maximum rigidity, its perfect volume uniformity and its very good dimensional stability, it offers excellent printability and runnability characteristics. This paper is guaranteed for personalized laser and inkjet post-printing. Cross is available in a very wide range of substances, making it suitable for all applications.





































Available from 50 gsm to 400 gsm

Cross also complements the Clairalfa and Smart Print ranges in A4 and A3 from 50 gsm to 350 gsm.





















Areas of end use: letterheads, invoices, receipts, forms and documents, company brochures, leaflets, personalised mailings, instructions for use, advertising leaflets, books, business reports, office supplies, catalogues, business cards.



CROSS BRIGHT

	Ref.	Sizes (mm)	Gsm	Pallet Sizes (mm)	Stacks	Sheets / Pallet	Tabbed by	Pallet Net Weight (kg)
	2897C	450 x 320	80g	670 x 940	4	40 000	-	461
	2898C	450 x 320	90g	670 x 940	4	36 000	-	467
	1934C	450 x 320	50g	670 x 940	4	60 000	1000	432
	1937C	450 x 320	60g	670 x 940	4	52 000	500	449
	4532C	450 x 320	80g	670 x 940	4	40 000	500	461
	2891SC	450 x 320	90g	670 x 940	4	36 000	500	467
	1956SC	450 x 320	100g	670 x 940	4	30 000	500	432
	1958C	450 x 320	120g	670 x 940	4	20 000	250	346
	1957C	450 x 320	160g	670 x 940	4	20 000	250	461
	1962C	450 x 320	200g	670 x 940	4	18 000	250	544
	1964C	450 x 320	250g	670 x 940	4	15 000	125	540
	1961C	450 x 320	300g	670 x 940	4	10 000	125	432
	1985C	450 x 320	350g	670 x 940	4	10 000	125	504
	3963C	430 x 610	70g	670 x 940	2	20 000	500	367
	4300C	430 x 610	80g	670 x 940	2	18 000	500	378
	3965C	430 x 610	70g	920 x 660	2	28 000	500	514
	3964C	440 x 630	80g	670 x 940	2	18 000	500	399
	2834SC	440 x 630	90g	670 x 940	2	16 000	500	399
	3966C	440 x 630	80g	940 x 670	2	18 000	500	399
	2818SC	450 x 640	50g	670 x 940	2	30 000	500	432
	2823SC	450 x 640	60g	670 x 940	2	22 000	500	380
	4500C	450 x 640	80g	670 x 940	2	18 000	500	415
	2808SC	450 x 640	90g	670 x 940	2	16 000	500	415
	2828C	450 x 640	100g	940 x 670	2	15 000	500	432
	2829C	450 x 640	120g	670 x 940	2	13 000	250	449
	2822C	450 x 640	160g	670 x 940	2	10 000	250	461
	2825C	450 x 640	200g	670 x 940	2	7 500	125	432
	2826C	450 x 640	240g	670 x 940	2	6 500	125	449
	3996SC	450 x 640	60g	960 x 690	2	32 000	500	553
	4564C	450 x 640	80g	960 x 690	2	24 000	500	553
	2806C	450 x 640	90g	960 x 690	2	22 000	500	570
	2824SC	450 x 640	100g	960 x 690	2	19 000	500	547
	2836SC	450 x 640	120g	960 x 690	2	13 000	250	449
	3967C	450 x 640	160g	960 x 690	2	12 000	250	553
	2837SC	450 x 640	200g	960 x 690	2	10 000	125	576
	2838C	450 x 640	240g	960 x 690	2	8 000	125	553





CROSS BRIGHT

	Ref.	Sizes (mm)	Gsm	Pallet Sizes (mm)	Stacks	Sheets / Pallet	Tabbed by	Pallet Net Weight (kg)
	3941C	460 × 640	60g	670 × 940	2	24 000	500	424
	3942C	460 × 640	70g	670 × 940	2	22 000	500	453
	3931C	460 × 640	80g	670 × 940	2	18 000	500	424
	3932C	460 × 640	90g	670 × 940	2	16 000	500	424
	3933C	460 × 640	100g	670 × 940	2	15 000	500	442
	3934C	460 × 640	120g	670 × 940	2	13 000	250	459
	3935C	460 × 640	160g	670 × 940	2	10 000	250	471
	3936C	460 × 640	200g	670 × 940	2	7 500	125	442
	3937C	460 × 640	240g	670 × 940	2	6 500	125	459
	3938C	640 × 460	100g	670 × 940	2	15 000	500	442
	3939C	640 × 460	120g	670 × 940	2	13 000	250	459
	3940C	640 × 460	160g	670 × 940	2	10 000	250	471
	2856C	630 × 880	50g	920 × 660	1	17 500	500	485
	2812C	630 × 880	80g	920 × 660	1	9 000	250	399
	2857C	880 × 630	50g	920 × 660	1	17 500	500	485
	2858C	880 × 630	60g	920 × 660	1	12 000	500	399
	3912C	880 × 630	70g	920 × 660	1	11 000	250	427
	8863C	880 × 630	80g	920 × 660	1	9 000	250	399
	2802C	880 × 630	90g	920 × 660	1	8 000	250	399
	3914C	880 × 630	100g	920 × 660	1	7 500	250	416
	2815C	880 × 630	120g	920 × 660	1	7 000	250	466
	2830C	880 × 630	160g	920 × 660	1	6 000	250	532
	3968C	880 × 630	70g	920 × 660	1	14 000	250	543
	3969C	880 × 630	80g	920 × 660	1	9 000	250	399
	3994C	880 × 630	90g	920 × 660	1	8 000	250	399
	2839SC	880 × 630	120g	920 × 660	1	7 000	250	466
	3995C	880 × 630	160g	920 × 660	1	6 000	250	532
	6011C	635 × 900	80g	920 × 660	1	9 000	250	411
	6012C	635 × 900	90g	920 × 660	1	8 000	250	411
	6016C	635 × 900	100g	920 × 660	1	7 500	250	429
	6017C	635 × 900	120g	920 × 660	1	6 500	250	446
	6018C	635 × 900	160g	920 × 660	1	5 000	125	457
	6019C	900 × 635	80g	920 × 660	1	9 000	250	411
	6020C	900 × 635	90g	920 × 660	1	8 000	250	411
	6023C	900 × 635	100g	920 × 660	1	7 500	250	429
	6024C	900 × 635	120g	920 × 660	1	6 500	250	446
	6025C	900 × 635	160g	920 × 660	1	5 000	125	457

CROSS BRIGHT

	Ref.	Sizes (mm)	Gsm	Pallet Sizes (mm)	Stacks	Sheets / Pallet	Tabbed by	Pallet Net Weight (kg)
	2819SC	650 x 920	50g	960 x 690	1	17 500	500	523
	6500C	650 x 920	80g	960 x 690	1	9 000	250	431
	2809C	650 x 920	90g	960 x 690	1	8 000	250	431
	2821SC	650 x 920	110g	960 x 690	1	7 000	250	460
	3943C	650 x 920	120g	960 x 690	1	6 500	250	466
	3944C	650 x 920	160g	960 x 690	1	5 000	125	478
	2860C	650 x 920	200g	960 x 690	1	3 750	125	449
	2861C	650 x 920	240g	960 x 690	1	3 250	125	466
	6592C	650 x 920	80g	960 x 690	1	9 000	250	431
	2807C	650 x 920	90g	960 x 690	1	11 000	250	592
	3822C	920 x 650	80g	940 x 670	1	9 000	250	431
	3823C	920 x 650	90g	940 x 670	1	8 000	250	431
	3945C	920 x 650	100g	670 x 940	1	7 500	250	449
	3946C	920 x 650	120g	670 x 940	1	6 500	250	466
	3947C	920 x 650	160g	670 x 940	1	5 000	125	478
	2862C	920 x 650	200g	670 x 940	1	3 750	125	449
	2865C	920 x 650	240g	670 x 940	1	3 250	125	466
	2842C	700 x 1000	70g	1040 x 720	1	11 000	250	539
	3948C	700 x 1000	80g	1040 x 720	1	9 000	250	504
	3949C	700 x 1000	90g	1040 x 720	1	8 000	250	504
	3950C	700 x 1000	100g	1040 x 720	1	7 500	250	525
	3951C	700 x 1000	120g	1040 x 720	1	6 500	250	546
	3952C	700 x 1000	160g	1040 x 720	1	5 000	125	560
	3953C	700 x 1000	200g	1040 x 720	1	3 750	125	525
	3954C	700 x 1000	240g	1040 x 720	1	3 250	125	546
	3890C	700 x 1000	240g	1040 x 720	1	3 250	125	546
	2851C	700 x 1000	300g	1040 x 720	1	2 600	100	546
	3891C	700 x 1000	300g	1040 x 720	1	2 600	100	546
	2853C	700 x 1000	400g	1040 x 720	1	2 000	50	560
	3892C	700 x 1000	400g	1040 x 720	1	2 000	50	560
	2811C	1000 x 700	80g	1040 x 720	1	9 000	250	504
	3955C	1000 x 700	90g	1040 x 720	1	8 000	250	504
	3956C	1000 x 700	100g	1040 x 720	1	7 500	250	525
	3957C	1000 x 700	120g	1040 x 720	1	6 500	250	546
	3958C	1000 x 700	160g	1040 x 720	1	5 000	125	560
	3959C	1000 x 700	200g	1040 x 720	1	3 750	125	525
	3960C	1000 x 700	240g	1040 x 720	1	3 250	125	546
	3893C	1000 x 700	240g	1040 x 720	1	3 250	125	546

CROSS BRIGHT

Ref.	Sizes (mm)	Gsm	Pallet Sizes (mm)	Stacks	Sheets / Pallet	Tabbed by	Pallet Net Weight (kg)
 2852C	1000 x 700	300g	1040 x 720	1	2 600	100	546
 3894C	1000 x 700	300g	1040 x 720	1	2 600	100	546
 3929C	1000 x 700	350g	1040 x 720	1	2 200	100	539
 2854C	1000 x 700	400g	1040 x 720	1	2 000	50	560
 3895C	1000 x 700	400g	1040 x 720	1	2 000	50	560



STOCKED ENVELOPES

80 - 90 gsm

ADHESIVE ENVELOPES / POCKETS

Ref.	Sizes (mm)	Gsm	Flap	Window	Units / Box	Box / Weight (kg)	Pallet Sizes (mm)	Units / Pallet	Pallet Net Weight (kg)
1431C	C6 - 114 x 162	80	adhesive	∅	500	1,65	120 x 80	98	162
1400C	DL - 110 x 220	80	adhesive	∅	500	2,20	120 x 80	104	230
1600C	DL - 110 x 220	90	adhesive	∅	250	1,40	120 x 80	198	278
1401C	DL - 110 x 220	80	adhesive	35x100 (20/20)	500	2,20	120 x 80	104	230
1601C	DL - 110 x 220	90	adhesive	35x100 (20/20)	250	1,40	120 x 80	198	278
1402C	DL - 110 x 220	80	adhesive	45x100 (20/20)	500	2,20	120 x 80	104	230
1603C	DL - 110 x 220	80	adhesive	45x100 (20/20)	250	1,40	120 x 80	198	278
1403C	DL - 110 x 220	80	adhesive	45x90 (15/20)	500	2,20	120 x 80	104	230
1429C	C6/5 - 114 x 229	80	adhesive	∅	500	2,40	120 x 80	96	230
1430C	C6/5 - 114 x 229	80	adhesive	40x110 (30/20)	500	2,60	120 x 80	96	230
1604SC	C5 - 162 x 229	90	adhesive	∅	250	2,15	120 x 80	120	258
1605C	C5 - 162 x 229	90	adhesive	45x100 (62/20)	250	2,15	120 x 80	120	258
1410C	C4 - 229 x 324	90	adhesive	∅	250	3,80	120 x 80	56	251
1411C	C4 - 229 x 324	90	adhesive	50x100 (50/20)	250	3,70	120 x 80	56	245
1412C	C4 - 229 x 324	90	adhesive	55x90 (55/20)	250	3,70	120 x 80	56	245

C6 - 114x162mm



C6/5 - 114x229mm

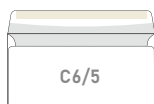

Window : 40x110

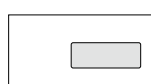

DL - 110x220mm



Window : 35x100

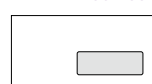

Window : 45x100

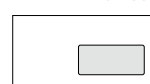

Window : 45x90

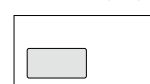

C5 - 162x229mm

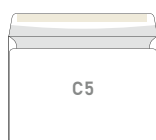

Window : 45x100

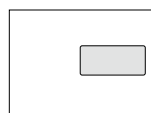

C4 - 229x324mm

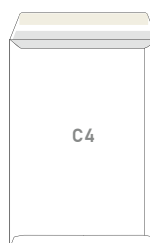

Window : 50x100

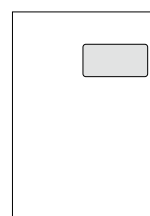

Window : 55x90

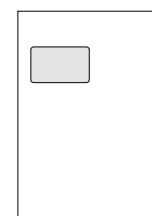



STOCKED ENVELOPES

80 gsm

GUMMED ENVELOPES

Ref.	Sizes (mm)	Gsm	Flap	Window	Units / Box	Box / Weight (kg)	Pallet Sizes (mm)	Units / Pallet	Pallet Net Weight (kg)
1457C	C6/5 - 114 x 229	80	gummed	∅	500	2,49	120 x 80	96	230
1458C	C6/5 - 114 x 229	80	gummed	35x100 (20/20)	500	2,45	120 x 80	96	230
1459C	C6/5 - 114 x 229	80	gummed	45x100 (20/20)	500	2,45	120 x 80	96	230
1460C	C5 - 162 x 229	80	gummed	∅	500	3,48	120 x 80	104	230
1464C	C5 - 162 x 229	80	gummed	45x100 (62/20)	500	3,46	120 x 80	104	230

C6/5 - 114x229mm

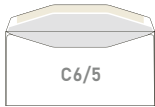

Window : 35x100

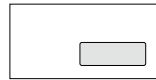

Window : 45x100

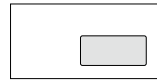

C5 - 162x229mm

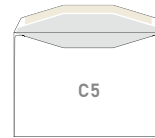

Window : 45x100

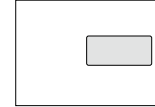

BRUT BRIGHT
ROUGH BRIGHT
INDIGO BRIGHT
SILK BRIGHT
BRUT ORIGINAL
ROUGH ORIGINAL
INDIGO ORIGINAL
SILK ORIGINAL
BRUT NATURAL WHITE
ROUGH NATURAL WHITE
BRUT NATURAL
ROUGH NATURAL
SILK NATURAL



REBECCA Rock





FICHE TECHNIQUE / code 811-731-542 TECHNICAL DATA SHEET

	80	100	120	150	200	240	300	350	400
Thickness (µm)	116	145	174	217	280	336	420	490	560
Bulk (cm³/g)	1.45	1.45	1.45	1.45	1.40	1.40	1.40	1.40	1.40
Bendtsen Roughness (ml/min)	450	550	550	550	550	550	550	650	750
Absolute Humidity (%H ₂ O)	5.0	5.0	5.5	6.0	6.5	6.5	7.0	7.0	7.0
Relative Humidity (% in the air)	38	38	44	44	48	55	60	60	60
Opacity (%)	93	97	98	>98	>99	>99	>99	>99	>99

GAMME RANGE

	80	100	120	150	200	240	300	350	400
460 x 640 mm	5305C	5306C	5313C	5314C					
640 x 460 mm	5315C	5316C	5317C	5318C					
650 x 920 mm	5423C	5425C	5427C	5447C					
920 x 650 mm	5424C	5426C	5429C	5448C					
700 x 1000 mm			5437C	5454C	5464C	5468C	5477C		5484C
700 x 1000 mm			5437PC	5454PC	5464PC	5468PC	5477PC		5484PC
720 x 1020 mm			OLI0195SC	5489C	5494C		OLI0199SC	5499C	5497C
1000 x 700 mm			5444C	5457C	5467C	5474C	5479C		5487C



BRUT BRIGHT









































REBECCA Rock

Une rugosité élevée, une main exceptionnelle sont les deux principales caractéristiques marquantes de ce support unique. Brut Bright offre à la fois un toucher brut et une imprimabilité parfaite. Ces deux propriétés, rugosité élevée et imprimabilité, en principe antinomiques, sont obtenues grâce au traitement de surface exclusif développé par Clairefontaine. Blancheur élevée de 170 CIE pour un contraste d'impression éclatant. Disponible de 80 g/m² à 400 g/m².

An exceptional touch.
Brut Bright reinvents the surface of offset printing papers. A high roughness and an exceptional bulk are the two main landmark characteristics of this unique medium. Brut Bright offers both a very rough touch and a perfect printability. These two properties, which are in principle opposite, are obtained thanks to the exclusive treatment that Clairefontaine applies to its surface. High whiteness of 170 CIE for brilliant print contrast. Available from 80 gsm to 400 gsm.



BRUT BRIGHT

	Ref.	Sizes (mm)	Gsm	Pallet Sizes (mm)	Stacks	Sheets / Pallet	Tabbed by	Pallet Net Weight (kg)
	5305C	460 x 640	80g	940 x 670	2	20 000	500	471
	5306C	460 x 640	100g	940 x 670	2	16 000	500	471
	5313C	460 x 640	120g	940 x 670	2	13 000	250	459
	5314C	460 x 640	150g	940 x 670	2	10 000	250	442
	5315C	640 x 460	80g	940 x 670	2	20 000	500	471
	5316C	640 x 460	100g	940 x 670	2	16 000	500	471
	5317C	640 x 460	120g	940 x 670	2	13 000	250	459
	5318C	640 x 460	150g	960 x 690	2	10 000	250	442
	5423C	650 x 920	80g	960 x 690	1	10 000	250	478
	5425C	650 x 920	100g	960 x 690	1	8 000	250	478
	5427C	650 x 920	120g	960 x 690	1	7 000	250	502
	5447C	650 x 920	150g	960 x 690	1	5 000	125	449
	5424C	920 x 650	80g	960 x 690	1	10 000	250	478
	5426C	920 x 650	100g	960 x 690	1	8 000	250	478
	5429C	920 x 650	120g	960 x 690	1	7 000	250	502
	5448C	920 x 650	150g	960 x 690	1	5 000	125	449
	5437C	700 x 1000	120g	1040 x 720	1	7 000	250	588
	5454C	700 x 1000	150g	1040 x 720	1	5 000	125	525
	5464C	700 x 1000	200g	1040 x 720	1	3 750	125	525
	5468C	700 x 1000	240g	1040 x 720	1	3 000	125	504
	5477C	700 x 1000	300g	1040 x 720	1	2 800	100	588
	5484C	700 x 1000	400g	1040 x 720	1	2 000	50	560
	5437PC	700 x 1000	120g	960 x 690	1	7 000	250	502
	5454PC	700 x 1000	150g	960 x 690	1	5 000	125	449
	5464PC	700 x 1000	200g	1040 x 720	1	7 000	250	588
	5468PC	700 x 1000	240g	1040 x 720	1	5 000	125	525
	5477PC	700 x 1000	300g	1040 x 720	1	3 750	125	525
	5484PC	700 x 1000	400g	1040 x 720	1	3 000	125	504
	5477C	700 x 1000	300g	1040 x 720	1	2 800	100	588
	5484C	700 x 1000	400g	1040 x 720	1	2 000	50	560
	5494C	720 x 1020	200g	1050 x 750	1	3 750	125	551
	OLI0199SC	720 x 1020	300g	1050 x 750	1	2 800	100	617
	5499C	720 x 1020	350g	1050 x 750	1	2 500	50	643
	5497C	720 x 1020	400g	1050 x 750	1	2 000	50	588
	5444C	1000 x 700	120g	1040 x 720	1	7 000	250	588
	5457C	1000 x 700	150g	1040 x 720	1	5 000	125	525
	5467C	1000 x 700	200g	1040 x 720	1	3 750	125	525
	5474C	1000 x 700	240g	1040 x 720	1	3 000	125	504
	5479C	1000 x 700	300g	1040 x 720	1	2 800	100	588
	5487C	1000 x 700	400g	1040 x 720	1	2 000	50	560

ROUGH BRIGHT



FICHE TECHNIQUE / code 711-715-757-536 TECHNICAL DATA SHEET

	80	90	100	120	150	170	200	240	300	350	400
Thickness (µm)	109	122	133	160	195	221	260	324	390	455	520
Bulk (cm³/g)	1.36	1.36	1.33	1.33	1.30	1.30	1.30	1.35	1.30	1.30	1.30
Bendtsen Roughness (ml/min)	245	245	245	245	245	245	245	300	300	300	300
Absolute Humidity (%H ₂ O)	5.0	5.0	5.0	5.5	6.0	6.0	6.5	6.5	6.5	7.0	7.0
Relative Humidity (% in the air)	38	38	38	44	44	44	48	48	50	60	60
Opacity (%)	94	96	97	98	>99	>99	>99	>99	>99	>99	>99

GAMME RANGE

	80	90	100	120	150	170	200	240	300	350	400
450 x 320 mm	F3331C	F3333C									
450 x 320 mm	F3332C	F3341C									
450 x 640 mm	F0371C	F0378C									
460 x 340 mm		F3342C									
460 x 640 mm	F0372C	F0379C	F0385C	F0519C	F0397C	F0403C	F0409C	F0425C			
640 x 460 mm		F0380C	F0386C	F0520C	F0398C	F0404C					
650 x 920 mm	F0374C	F0381C	F0387C	F0393C	F0399C	F0405C		F0565C			
920 x 650 mm	F0375C	F0382C	F0388C	F0394C	F0400C	F0406C		F0566C			
700 x 1000 mm	F0376C	5220PC	5221PC	5222PC	5223PC	5224PC	5225PC				
1000 x 700 mm		F0384C	F0390C	F0396C	F0402C	F0408C	F0412C				
720 x 1020 mm								5226PC	5227PC	5500C	5228PC
1020 x 720 mm								F0427C	F0682C		F0431C



Please collect used paper for recycling



The mark of responsible forestry



170 CIE



ROUGHNESS

ROUGH BRIGHT

REBECCA Rock

Voici un papier de caractère !

Rough Bright présente une surface texturée, dont vous aurez plaisir à sentir les fibres.

Sa main élevée et son excellente rigidité en font un support idéal pour vos travaux de création. Extrêmement blanc, il rehausse l'intensité des couleurs imprimées, et rend notre message plus dynamique, plus percutant.

Certes un papier de caractère mais il sait se montrer conciliant.

La surface de Rough a été traitée pour une excellente machinabilité, des impressions contrastées et uniformes ; il est apte à de multiples finitions.

Comme tous les papiers de la gamme, Rough Bright présente une excellente stabilité dimensionnelle, une formation de feuille très fondue.

Disponible de 80 g/m² à 400 g/m².

Here's a paper of character!

Rough Bright has a textured surface, the fibres you'll be pleased to feel.

Its high bulk and its excellent stiffness make it an ideal substrate for your creative works. Extremely white, it enhances the intensity of the printed colours, and makes the message more dynamic and impactful.

Certainly, a paper with character, but it knows how to be accommodating.

The surface of Rough has been treated for an excellent runnability, contrasting and uniform prints, and is suitable for multiple finishes.

Like all the papers in the range, Rough Bright has an excellent dimensional stability and a consistent sheet formation.

















Available from 80 gsm to 400 gsm.



ROUGH BRIGHT

	Ref.	Sizes (mm)	Gsm	Pallet Sizes (mm)	Stacks	Sheets / Pallet	Tabbed by	Pallet Net Weight (kg)
	F3332C	450 x 320	80g	940 x 670	4	40 000	500	461
	F3341C	450 x 320	90g	940 x 670	4	36 000	500	467
	F3331C	450 x 320	80g	940 x 670	4	40 000	500	461
	F3333C	450 x 320	90g	940 x 670	4	36 000	500	467
	F3342C	460 x 340	90g	960 x 690	4	36 000	500	507
	F0371C	450 x 640	80g	940 x 670	2	20 000	500	461
	F0378C	450 x 640	90g	940 x 670	2	18 000	500	518
	F0372C	460 x 640	80g	940 x 670	2	20 000	500	471
	F0379C	460 x 640	90g	940 x 670	2	18 000	500	477
	F0385C	460 x 640	100g	940 x 670	2	16 000	500	471
	F0519C	460 x 640	120g	940 x 670	2	13 000	250	459
	F0397C	460 x 640	150g	940 x 670	2	12 000	250	530
	F0403C	460 x 640	170g	940 x 670	2	11 000	250	551
	F0409C	460 x 640	200g	940 x 670	2	9 500	250	559
	F0425C	460 x 640	240g	940 x 670	2	7 000	125	459
	F0380C	640 x 460	90g	940 x 670	2	18 000	500	477
	F0386C	640 x 460	100g	940 x 670	2	16 000	500	471
	F0520C	640 x 460	120g	940 x 670	2	13 000	250	459
	F0398C	640 x 460	150g	940 x 670	2	12 000	250	530
	F0404C	640 x 460	170g	940 x 670	2	11 000	250	551
	F0374C	650 x 920	80g	960 x 690	1	10 000	500	478
	F0381C	650 x 920	90g	960 x 690	1	9 000	250	484
	F0387C	650 x 920	100g	960 x 690	1	8 000	250	478
	F0393C	650 x 920	120g	960 x 690	1	7 000	250	502
	F0399C	650 x 920	150g	960 x 690	1	5 000	125	449
	F0405C	650 x 920	170g	960 x 690	1	4 500	125	457
	F0565C	650 x 920	240g	960 x 690	1	3 500	125	502
	F0375C	920 x 650	80g	960 x 690	1	10 000	500	478
	F0382C	920 x 650	90g	960 x 690	1	9 000	250	484
	F0388C	920 x 650	100g	960 x 690	1	8 000	250	478
	F0394C	920 x 650	120g	960 x 690	1	7 000	250	502
	F0400C	920 x 650	150g	960 x 690	1	5 000	125	449
	F0406C	920 x 650	170g	960 x 690	1	4 500	125	457
	F0566C	920 x 650	240g	960 x 690	1	3 500	125	502
	F0376C	700 x 1000	80g	1040 x 720	1	9 000	250	504
	5220PC	700 x 1000	90g	1040 x 720	1	9 000	250	567
	5221PC	700 x 1000	100g	1040 x 720	1	8 000	250	560

ROUGH BRIGHT

	Ref.	Sizes (mm)	Gsm	Pallet Sizes (mm)	Stacks	Sheets / Pallet	Tabbed by	Pallet Net Weight (kg)
	5222PC	700 × 1000	120g	1040 × 720	1	7 000	250	588
	5223PC	700 × 1000	150g	1040 × 720	1	5 000	125	525
	5224PC	700 × 1000	170g	1040 × 720	1	4 000	125	476
	5225PC	700 × 1000	200g	1040 × 720	1	4 500	125	630
	F0384C	1000 × 700	90g	1040 × 720	1	9 000	250	567
	F0390C	1000 × 700	100g	1040 × 720	1	8 000	250	560
	F0396C	1000 × 700	120g	1040 × 720	1	7 000	250	588
	F0402C	1000 × 700	150g	1040 × 720	1	5 000	125	525
	F0408C	1000 × 700	170g	1040 × 720	1	4 000	125	476
	F0412C	1000 × 700	200g	1040 × 720	1	4 500	125	630
	5226PC	720 × 1020	240g	1050 × 750	1	3 000	125	529
	5227PC	720 × 1020	300g	1050 × 750	1	3000	50	661
	5500C	720 × 1020	350g	1050 × 750	1	2500	50	643
	5228PC	720 × 1020	400g	1050 × 750	1	2 000	50	588
	F0427C	1020 × 720	240g	1050 × 750	1	3 000	125	529
	F0682C	1020 × 720	300g	1050 × 750	1	3 000	50	661
	F0431C	1020 × 720	400g	1050 × 750	1	2 000	50	588

INDIGO BRIGHT



FICHE TECHNIQUE / code 732-538 TECHNICAL DATA SHEET

	90	100	120	150	170	200	240	300	350
Thickness (µm)	122	133	160	218	221	260	324	405	472
Bulk (cm ³ /g)	1.36	1.33	1.33	1.36	1.30	1.30	1.35	1.35	1.35
Bendtsen Roughness (ml/min)	245	245	245	245	245	245	245	245	300
Absolute Humidity (%H ₂ O)	5.3	5.3	5.3	6.0	6.0	6.5	6.5	6.5	6.5
Relative Humidity (% in the air)	42	42	42	42	48	50	50	50	55
Opacity (%)	93	94.5	>99	>99	>99	>99	>99	>99	>99

GAMME RANGE

	90	100	120	150	170	200	240	300	350
320 x 460 mm	4061C	4062C	4063C						
460 x 320 mm	4066C	4067C	4068C				4072C	4073C	
530 x 750 mm			4003C	4004C	4005C	4006C	4007C	4008C	4009C
750 x 530 mm			4011C		4013C				



Please collect used paper for recycling



The mark of responsible forestry



170 CIE



ROUGHNESS

INDIGO BRIGHT

REBECCA Rock

Indigo Bright offre les mêmes caractéristiques que les autres papiers Rough Bright : blancheur extrême pour des impressions contrastées, main élevée, surface texturée dont vous aurez plaisir à sentir les fibres. Il offre également une excellente stabilité dimensionnelle et une formation de feuille très fondue. Sa surface a été spécialement traitée pour des impressions exceptionnelles sur les machines HP Indigo. Disponible de 120 g/m² à 350 g/m².

















Indigo Bright offers the same properties as the others papers of the Rough Bright range: extreme whiteness for accurate prints, high bulk, textured surface on which you will feel the fibres. It has a high dimensional stability and a uniform sheet formation.

Its surface has been modified for outstanding prints on HP Indigo machines.

Available from 120 gsm to 350 gsm.



INDIGO BRIGHT

	Ref.	Sizes (mm)	Gsm	Pallet Sizes (mm)	Stacks	Sheets / Pallet	Tabbed by	Pallet Net Weight (kg)
	4061C	320 x 460	90g	940 x 670	4	36000	500	477
	4062C	320 x 460	100g	940 x 670	4	28000	500	412
	4066C	460 x 320	90g	940 x 670	4	36000	500	477
	4067C	460 x 320	100g	940 x 670	4	28000	500	412
	4063C	320 x 460	120g	940 x 670	4	24 000	250	424
	4068C	460 x 320	120g	940 x 670	4	24 000	250	424
	4072C	460 x 320	240g	940 x 670	4	12 000	125	424
	4073C	460 x 320	300g	940 x 670	4	10 000	125	442
	4003C	530 x 750	120g	1120 x 820	2	12 000	250	572
	4004C	530 x 750	150g	1120 x 820	2	10 000	250	596
	4006C	530 x 750	200g	1120 x 820	2	8 000	125	636
	4007C	530 x 750	240g	1120 x 820	2	6 000	125	572
	4008C	530 x 750	300g	1120 x 820	2	5 000	125	596
	4009C	530 x 750	350g	1120 x 820	2	4 500	125	626
	4011C	750 x 530	120g	1120 x 820	2	12 000	250	572
	4005C	530 x 750	170g	1120 x 820	2	9500	125	642
	4013C	750 x 530	170g	1120 x 820	2	9500	125	642

SILK BRIGHT



FICHE TECHNIQUE / code 121-309 TECHNICAL DATA SHEET

	90	100	120	160	200	250	300	350
Thickness (µm)	99	110	125	161	168	248	297	346
Bulk (cm ³ /g)	1.10	1.10	1.04	1.01	0.99	0.99	0.99	0.99
Bekk Smoothness (s)	120	120	120	120	120	100	60	60
Absolute Humidity (%H ₂ O)	5.0	5.0	5.5	6.0	6.5	6.5	7.0	7.0
Relative Humidity (% in the air)	38	38	44	48	50	50	60	60
Opacity (%)	93	94.5	97	>99	>99	>99	>99	>99

GAMME RANGE

	90	100	120	160	200	250	300	350
460 x 640 mm	3501C	3502C	3503C	3504C	3505C	3158C	3156SC	3157SC
700 x 1000 mm	3506C	3507C	3508C	3509C	3510C	3161C	3165SC	3166SC
700 x 1000 mm	3506PC	3507PC	3508PC	3509PC	3510PC	3161PC	3165PC	3166PC
1000 x 700 mm	3511C	3512C	3513C	3514C	3163C	3167SC	3168SC	

SPECIAL PREPRINT / code 051

BLANC WHITE	80	90	100	120	160	200	250	280	300	350	400
320 x 450 mm		6805C	6801C	6806C	6810C	6811C	6813C		6802C	6803C	
450 x 320 mm	1809C	6900C	6901C	6902C	6903C	6815C	6906C	6907C	6908C	6909C	3812C
450 x 640 mm		1826C	1827C			3815C	1825SC	1823SC	3805C	3814C	3813C
IVOIRE IVORY											
450 x 320 mm			6835C			6836C	6834C		6839C	6821C	



SILK BRIGHT

REBECCA Rock

Les atouts du non-couché et du couché réunis pour un papier d'exception.

Silk Bright offre l'élégance d'un papier naturel avec un toucher soyeux exclusif et une surface agréable et sensuelle évoquant la soie. Le rendu d'impression et la brillance d'encre égalent ceux d'un papier couché, avec en particulier une excellente reproduction de la couleur. Ultra blanc (167 CIE), et avec un épaisseur extrêmement homogène il garantit une fidélité des détails et un haut contraste. Ce papier a pris le meilleur des deux mondes, Silk Bright se prête bien au gaufrage, au rainage et à l'estampage. De plus, sa surface pigmentée le rend compatible avec les impressions Inkjet.

Disponible de 90 g/m² à 350 g/m².

De même satinage et de même blancheur, nous proposons également la gamme DCP en formats A4, A3, 45 x 32 et 45 x 64 de 80 g/m² à 400 g/m² adaptée aux copieurs couleurs, transfert thermique et imprimantes laser couleur.

Domaines d'utilisation : rapports d'activité, brochures et publicités de haute qualité, cartes de visite, cartes de compliments.

The advantages of an uncoated and a coated paper combined for an exceptional paper.































Silk Bright offers the elegance of a natural paper with an exclusive silky touch and a pleasant and sensual surface reminiscent of silk. The print quality and the ink brilliance match the ones of a coated paper, with a particularly excellent colour reproduction. Ultra-white (167 CIE) with an extremely homogenous formation, it guarantees precision of details and a high contrast. This paper has taken the best of both worlds, Silk Bright lends itself well to embossing, scoring and stamping. Available from 90 gsm to 350 gsm.

In addition, its pigmented surface makes it compatible with Inkjet printing. With the same satin finish and whiteness, we also offer the DCP range in A4, A3, 45 x 32 and 46 x 64 sizes from 80 gsm to 400 gsm suitable for colour copiers, thermal transfer and colour laser printers.

Areas of use: business reports, high quality brochures and advertising, business cards, compliment cards.





SILK BRIGHT













	Ref.	Sizes (mm)	Gsm	Pallet Sizes (mm)	Stacks	Sheets / Pallet	Tabbed by	Pallet Net Weight (kg)
	3501C	460 x 640	90g	940 x 670	2	22 000	500	583
	3502C	460 x 640	100g	940 x 670	2	20 000	500	589
	3503C	460 x 640	120g	940 x 670	2	17 000	250	601
	3504C	460 x 640	160g	940 x 670	2	12 000	250	565
	3505C	460 x 640	200g	940 x 670	2	10 000	250	589
	3158C	460 x 640	250g	940 x 670	2	8 000	125	589
	3156SC	460 x 640	300g	940 x 670	2	5 500	125	486
	3157SC	460 x 640	350g	940 x 670	2	5 000	125	515
	3506C	700 x 1000	90g	1040 x 720	1	9 000	250	567
	3507C	700 x 1000	100g	1040 x 720	1	8 000	250	560
	3508C	700 x 1000	120g	1040 x 720	1	7 000	250	588
	3509C	700 x 1000	160g	1040 x 720	1	5 000	125	560
	3510C	700 x 1000	200g	1040 x 720	1	3 500	125	490
	3161C	700 x 1000	250g	1040 x 720	1	3 000	100	525
	3165SC	700 x 1000	300g	1040 x 720	1	2 600	100	546
	3166SC	700 x 1000	350g	1040 x 720	1	2 400	100	588
	3506PC	700 x 1000	90g	1040 x 720	1	9 000	250	567
	3507PC	700 x 1000	100g	1040 x 720	1	8 000	250	560
	3508PC	700 x 1000	120g	1040 x 720	1	7 000	250	588
	3509PC	700 x 1000	160g	1040 x 720	1	5 000	125	560
	3510PC	700 x 1000	200g	1040 x 720	1	3 500	125	490
	3161PC	700 x 1000	250g	1040 x 720	1	3 000	100	525
	3165PC	700 x 1000	300g	1040 x 720	1	2 600	100	546
	3166PC	700 x 1000	350g	1040 x 720	1	2 400	100	588
	3511C	1000 x 700	100g	1040 x 720	1	8 000	250	560
	3512C	1000 x 700	120g	1040 x 720	1	7 000	250	588
	3513C	1000 x 700	160g	1040 x 720	1	5 000	125	560
	3514C	1000 x 700	200g	1040 x 720	1	3 500	125	490
	3163C	1000 x 700	250g	1040 x 720	1	3 000	100	525
	3167SC	1000 x 700	300g	1040 x 720	1	2 600	100	546
	3168SC	1000 x 700	350g	1040 x 720	1	2 400	100	588

SPECIAL PREPRINT





BLANC WHITE

	6805C	320 x 450	90g	940 x 670	4	40 000	500	518
	6801C	320 x 450	100g	940 x 670	4	40 000	500	576
	6806C	320 x 450	120g	940 x 670	4	20 000	250	346

SILK BRIGHT

	Ref.	Sizes (mm)	Gsm	Pallet Sizes (mm)	Stacks	Sheets / Pallet	Tabbed by	Pallet Net Weight (kg)
	6810C	320 x 450	160g	940 x 670	4	20 000	250	461
	6811C	320 x 450	200g	940 x 670	4	10 000	125	288
	6813C	320 x 450	250g	940 x 670	4	10 000	125	360
	6802C	320 x 450	300g	940 x 670	4	10 000	125	432
	6803C	320 x 450	350g	940 x 670	4	10 000	125	504
	1809C	450 x 320	80g	940 x 670	4	40 000	500	461
	6900C	450 x 320	90g	940 x 670	4	40 000	500	518
	6901C	450 x 320	100g	940 x 670	4	40 000	500	576
	6902C	450 x 320	120g	940 x 670	4	20 000	250	346
	6903C	450 x 320	160g	940 x 670	4	20 000	250	461
	6815C	450 x 320	200g	940 x 670	4	20 000	125	576
	6906C	450 x 320	250g	940 x 670	4	10 000	125	360
	6907C	450 x 320	280g	940 x 670	4	10 000	125	403
	6908C	450 x 320	300g	940 x 670	4	10 000	125	432
	6909C	450 x 320	350g	940 x 670	4	10 000	125	504
	3812C	450 x 320	400g	940 x 670	4	8 000	100	461
	1826C	450 x 640	90g	960 x 690	2	25 000	500	648
	1827C	450 x 640	100g	960 x 690	2	25 000	500	720
	3815C	450 x 640	200g	960 x 690	2	10 000	125	576
	1825SC	450 x 640	250g	960 x 690	2	8 000	125	576
	1823C	450 x 640	280g	960 x 690	2	5 000	125	403
	3805C	450 x 640	300g	960 x 690	2	5 000	125	432
	3814C	450 x 640	350g	960 x 690	2	5 000	125	504
	3813C	450 x 640	400g	960 x 690	2	4 600	100	530

IVOIRE IVORY



	6835C	450 x 320	100g	1000 x 690	4	40 000	500	576
	6836C	450 x 320	200g	1000 x 690	4	18 000	250	518
	6834C	450 x 320	250g	1000 x 690	4	10 000	125	360
	6839C	450 x 320	300g	1000 x 690	4	10 000	125	432
	6821C	450 x 320	350g	1000 x 690	4	10 000	125	504



FICHE TECHNIQUE / code 745-552 TECHNICAL DATA SHEET

	90	100	120	130	150	170	200	240	300	350	400
Thickness (µm)	131	145	180	189	218	238	280	336	420	490	560
Bulk (cm³/g)	1.45	1.45	1.45	1.45	1.45	1.4	1.4	1.4	1.4	1.4	1.4
Bendtsen Roughness (ml/min)	550	550	550	550	550	550	550	550	550	650	750
Absolute Humidity (%H ₂ O)	5.3	5.3	5.3	5.3	6.0	6.0	6.5	6.5	6.5	7.0	7.0
Relative Humidity (% in the air)	42	42	42	42	48	48	50	50	50	60	60
Opacity (%)	91	92	95	>99	>99	>99	>99	>99	>99	>99	>99

GAMME RANGE

	90	100	120	130	150	170	200	240	300	350	400
 720 x 1020 mm	5157C	5158C	5172C	5159C	5160C	5161C	OLI0219SC	5162C	5163C	5164C	5175C
 720 x 1020 mm	5157PC	5158PC	5172PC	5159PC	5160PC	5161PC	5176PC	5162PC	5163PC	5164PC	
 1020 x 720 mm		5174C	5173C	5166C	5167C	5168C		5169C	5170C	5171C	5176C



BRUT ORIGINAL







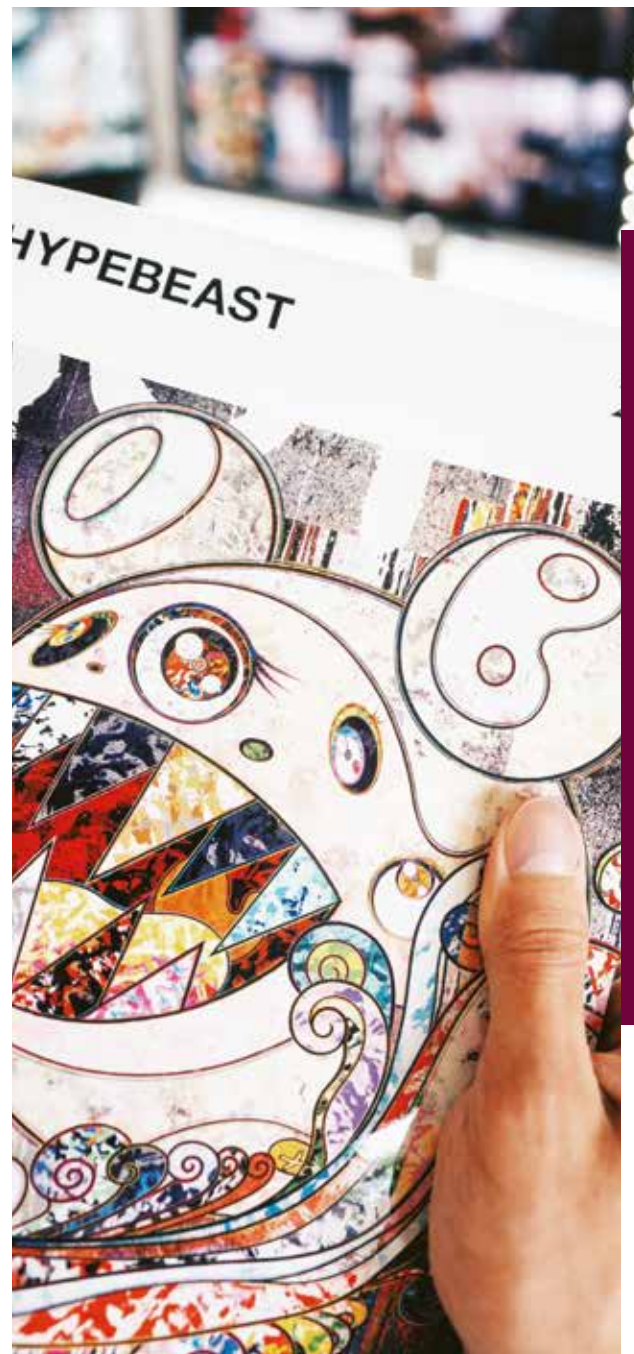























REBECCA Rock

Plongez dans une expérience tactile inégalée avec notre papier à la rugosité élevée. Avec sa main exceptionnelle, Brut Original offre un toucher brut et authentique, révélant sa texture sous vos doigts. Sa surface traitée lui confère une remarquable aptitude à l'impression et garantit ainsi des résultats parfaits pour chaque projet. Que ce soit pour des brochures ou des produits de communication Brut Original est le choix idéal pour ceux qui recherchent une qualité et une authenticité supérieure.

Dive into an unrivalled tactile experience with our high roughness paper. With its exceptional bulk, Brut Original offers a raw, authentic feel, revealing its texture under your fingers. Its treated surface gives it outstanding printability, guaranteeing perfect results for every project. Whether for brochures or communication products, Brut Original is the ideal choice for those seeking superior quality and authenticity.



BRUT ORIGINAL

	Ref.	Sizes (mm)	Gsm	Pallet Sizes (mm)	Stacks	Sheets / Pallet	Tabbed by	Pallet Net Weight (kg)
	5157C	720 x 1020	90g	750 x 1050	1	8 000	250	529
	5158C	720 x 1020	100g	750 x 1050	1	7 500	250	551
	5172C	720 x 1020	120g	750 x 1050	1	6 500	125	549
	5159C	720 x 1020	130g	750 x 1050	1	5 400	200	516
	5160C	720 x 1020	150g	750 x 1050	1	5 000	125	551
	5161C	720 x 1020	170g	750 x 1050	1	4 250	125	531
	OLI0219SC	720 x 1020	200g	750 x 1050	1	3 750	125	551
	5162C	720 x 1020	240g	750 x 1050	1	3 000	100	529
	5163C	720 x 1020	300g	750 x 1050	1	2 550	75	562
	5164C	720 x 1020	350g	750 x 1050	1	2 100	75	540
	5175C	720 x 1020	400g	750 x 1050	1	1800	50	529
	5157PC	720 x 1020	90g	750 x 1050	1	8 000	250	529
	5158PC	720 x 1020	100g	750 x 1050	1	7 500	250	551
	5172PC	720 x 1020	120g	750 x 1050	1	6 500	125	549
	5159PC	720 x 1020	130g	750 x 1050	1	5 400	200	516
	5160PC	720 x 1020	150g	750 x 1050	1	5 000	125	551
	5161PC	720 x 1020	170g	750 x 1050	1	4 250	125	531
	5176PC	720 x 1020	200g	750 x 1050	1	3 750	125	551
	5162PC	720 x 1020	240g	750 x 1050	1	3 000	100	529
	5163PC	720 x 1020	300g	750 x 1050	1	2 550	75	562
	5164PC	720 x 1020	350g	750 x 1050	1	2 100	75	540
	5174C	1020 x 720	100g	750 x 1050	1	7 500	250	551
	5173C	1020 x 720	120g	750 x 1050	1	6 500	125	549
	5166C	1020 x 720	130g	750 x 1050	1	5 400	200	516
	5167C	1020 x 720	150g	750 x 1050	1	5 000	125	551
	5168C	1020 x 720	170g	750 x 1050	1	4 250	125	531
	5169C	1020 x 720	240g	750 x 1050	1	3 000	100	529
	5170C	1020 x 720	300g	750 x 1050	1	2 550	75	562
	5171C	1020 x 720	350g	750 x 1050	1	2 100	75	540
	5176C	1020 x 720	400g	750 x 1050	1	1800	50	529



FICHE TECHNIQUE / code 707-531 TECHNICAL DATA SHEET

	90	100	115	130	150	170	200	240	300	350	400
Thickness (µm)	120	133	153	169	195	221	260	305	381	444	508
Bulk (cm ³ /g)	1.33	1.33	1.33	1.30	1.30	1.30	1.30	1.27	1.27	1.27	1.27
Bendtsen Roughness (ml/min)	250	250	250	250	250	300	300	300	300	300	300
Absolute Humidity (%H ₂ O)	5.6	5.6	5.6	5.6	6.0	6.0	6.5	6.5	6.5	7.0	7.0
Relative Humidity (% in the air)	45	45	45	45	45	45	50	50	50	60	60
Opacity (%)	92	93.5	95	96	97	98	98	>99	>99	>99	>99

GAMME RANGE

	90	100	115	130	150	170	200	240	300	350	400
450 x 320 mm		20600C	20601C	20602C	20603C	20604C		20605C	20606C	20607C	20608C
450 x 320 mm	Y3011C	Y3012C	Y3013C	Y3014C	Y3015C		Y3017C	Y3018C	Y3019C	Y3048C	Y3050C
460 x 640 mm	20609C	20610C			20611C			20612C	20613C	20614C	
460 x 640 mm	Y0037C	Y0038C	Y0039C	Y0040C	Y0041C	Y0042C	Y0043C	Y0044C	Y0045C	Y0046C	
640 x 900 mm				20615C							
640 x 900 mm	Y0056C	Y0057C	Y0058C	Y0059C	Y0060C	Y0061C	Y0062C	Y0063C	Y0064C		
900 x 640 mm				20622C	20623C			20624C	20625C		
900 x 640 mm	Y0074C	Y0075C	Y0076C	Y0077C	Y0078C	Y0079C	Y0080C	Y0081C	Y0082C		
720 x 1020 mm				20616C			20617C	20618C	20619C	20620C	20621C
720 x 1020 mm	20630C	20631C	20632C	20616C	20633C	20634C	Y0100C	Y0101C	Y0102C	Y0103C	Y0104C
1020 x 720 mm								20626C	20627C	20628C	20629C
1020 x 720 mm			Y0118C	Y0119C	Y0120C	Y0121C	Y0122C	Y0123C	Y0124C	Y0125C	Y0126C

STOCKED ENVELOPES CF. Page 56



ROUGH ORIGINAL





































REBECCA Rock

Rough Original est un papier d'une élégance rare. Sa blancheur naturelle offre un équilibre parfait à vos impressions couleurs. Son toucher texturé vous permet de sentir les fibres et la structure du papier. Sa main élevée et sa formation de feuille très homogène en font le support idéal pour tous vos travaux de création. Sa surface traitée lui confère une excellente machinabilité et un rendu d'impression contrasté et parfaitement uniforme. Rough Original est également décliné en version Silk et HP Indigo. Disponible de 90 g/m² à 400 g/m².

































Rough Original is a paper of a rare elegance. Its natural whiteness offers a perfect balance to your colour prints. Its textured touch allows you to feel the fibres and the structure of the paper. Its high bulk and homogenous sheet formation make it the ideal medium for all your creative works. Its treated surface gives it an excellent runnability with a contrasting and perfectly uniform printing result. Rough Original is also available in Silk and HP Indigo versions. Available from 90 gsm to 400 gsm.





















ROUGH ORIGINAL

	Ref.	Sizes (mm)	Gsm	Pallet Sizes (mm)	Stacks	Sheets / Pallet	Tabbed by	Pallet Net Weight (kg)
	Y3011C	450 x 320	90g	940 x 670	4	32 000	-	415
	Y3012C	450 x 320	100g	940 x 670	4	28 000	-	403
	Y3013C	450 x 320	115g	940 x 670	4	26 000	-	431
	Y3014C	450 x 320	130g	940 x 670	4	22 000	-	412
	Y3015C	450 x 320	150g	940 x 670	4	20 000	-	432
	Y3017C	450 x 320	200g	940 x 670	4	15 000	-	432
	Y3018C	450 x 320	240g	940 x 670	4	12 000	-	415
	Y3019C	450 x 320	300g	940 x 670	4	10 000	-	432
	Y3048C	450 x 320	350g	940 x 670	4	8 500	-	428
	Y3050C	450 x 320	400g	940 x 670	4	7 200	-	415
	20600C	450 x 320	100g	940 x 670	4	28 000	250	403
	20601C	450 x 320	115g	940 x 670	4	26 000	250	431
	20602C	450 x 320	130g	940 x 670	4	22 000	250	412
	20603C	450 x 320	150g	940 x 670	4	20 000	250	432
	20604C	450 x 320	170g	940 x 670	4	17 000	250	416
	20605C	450 x 320	240g	940 x 670	4	12 000	125	415
	20606C	450 x 320	300g	940 x 670	4	10 000	125	432
	20607C	450 x 320	350g	940 x 670	4	10 000	125	428
	20608C	450 x 320	400g	940 x 670	4	10 000	100	415
	Y0037C	460 x 640	90g	940 x 670	2	16 000	500	424
	Y0038C	460 x 640	100g	940 x 670	2	15 000	500	442
	Y0039C	460 x 640	115g	940 x 670	2	13 000	500	440
	Y0040C	460 x 640	130g	940 x 670	2	11 000	250	421
	Y0041C	460 x 640	150g	940 x 670	2	10 000	250	442
	Y0042C	460 x 640	170g	940 x 670	2	8 500	250	425
	Y0043C	460 x 640	200g	940 x 670	2	7 500	250	442
	Y0044C	460 x 640	240g	940 x 670	2	6 000	125	424
	Y0045C	460 x 640	300g	940 x 670	2	5 000	125	442
	Y0046C	460 x 640	350g	940 x 670	2	4 250	125	438
	20609C	460 x 640	90g	960 x 690	2	16 000	500	424
	20610C	460 x 640	100g	960 x 690	2	15 000	500	442
	20611C	460 x 640	150g	960 x 690	2	10 000	250	442
	20612C	460 x 640	240g	960 x 690	2	6 000	125	424
	20613C	460 x 640	300g	960 x 690	2	5 000	125	442
	20614C	460 x 640	350g	960 x 690	2	4 250	125	438
	Y0056C	640 x 900	90g	920 x 660	1	8 000	250	415
	Y0057C	640 x 900	100g	920 x 660	1	7 500	250	432

ROUGH ORIGINAL

	Ref.	Sizes (mm)	Gsm	Pallet Sizes (mm)	Stacks	Sheets / Pallet	Tabbed by	Pallet Net Weight (kg)
	Y0058C	640 x 900	115g	920 x 660	1	6 500	250	431
	Y0059C	640 x 900	130g	920 x 660	1	5 500	250	412
	Y0060C	640 x 900	150g	920 x 660	1	5 000	125	432
	Y0061C	640 x 900	170g	920 x 660	1	4 250	125	416
	Y0062C	640 x 900	200g	920 x 660	1	3 750	125	432
	Y0063C	640 x 900	240g	920 x 660	1	3 000	125	415
	Y0064C	640 x 900	300g	920 x 660	1	2 550	75	441
	20615C	640 x 900	130g	920 x 660	1	5 500	250	412
	20630C	720 x 1020	90g	1050 x 750	1	8 000	250	529
	20631C	720 x 1020	100g	1050 x 750	1	7 500	250	551
	20632C	720 x 1020	115g	1050 x 750	1	6 500	250	549
	20616C	720 x 1020	130g	1050 x 750	1	5400	200	516
	20633C	720 x 1020	150g	1050 x 750	1	5 000	125	551
	20634C	720 x 1020	170g	1050 x 750	1	4 250	125	531
	Y0100C	720 x 1020	200g	1050 x 750	1	3 750	125	551
	Y0101C	720 x 1020	240g	1050 x 750	1	3 000	100	529
	Y0102C	720 x 1020	300g	1050 x 750	1	2 550	75	562
	Y0103C	720 x 1020	350g	1050 x 750	1	2 100	75	540
	Y0104C	720 x 1020	400g	1050 x 750	1	1 800	50	529
	20616C	720 x 1020	130g	1050 x 750	1	5400	200	516
	20617C	720 x 1020	200g	1050 x 750	1	3 750	125	551
	20618C	720 x 1020	240g	1050 x 750	1	3 000	100	529
	20619C	720 x 1020	300g	1050 x 750	1	2 550	75	562
	20620C	720 x 1020	350g	1050 x 750	1	2 100	75	540
	20621C	720 x 1020	400g	1050 x 750	1	1 800	50	529
	Y0074C	900 x 640	90g	920 x 660	1	8 000	250	415
	Y0075C	900 x 640	100g	920 x 660	1	7 500	250	432
	Y0076C	900 x 640	115g	920 x 660	1	6 500	250	431
	Y0077C	900 x 640	130g	920 x 660	1	5 500	250	412
	Y0078C	900 x 640	150g	920 x 660	1	5 000	125	432
	Y0079C	900 x 640	170g	920 x 660	1	4 250	125	416
	Y0080C	900 x 640	200g	920 x 660	1	3 750	125	432
	Y0081C	900 x 640	240g	920 x 660	1	3 000	125	415

ROUGH ORIGINAL

	Ref.	Sizes (mm)	Gsm	Pallet Sizes (mm)	Stacks	Sheets / Pallet	Tabbed by	Pallet Net Weight (kg)
	Y0082C	900 x 640	300g	920 x 660	1	2 550	75	441
	20622C	900 x 640	130g	920 x 660	1	5 500	250	412
	20623C	900 x 640	150g	920 x 660	1	5 000	125	432
	20624C	900 x 640	240g	920 x 660	1	3 000	125	415
	20625C	900 x 640	300g	920 x 660	1	2 550	75	441
	Y0118C	1020 x 720	115g	1050 x 750	1	6 500	250	549
	Y0119C	1020 x 720	130g	1050 x 750	1	5 400	200	516
	Y0120C	1020 x 720	150g	1050 x 750	1	5 000	125	551
	Y0121C	1020 x 720	170g	1050 x 750	1	4 250	125	531
	Y0122C	1020 x 720	200g	1050 x 750	1	3 750	125	551
	Y0123C	1020 x 720	240g	1050 x 750	1	3 000	100	529
	Y0124C	1020 x 720	300g	1050 x 750	1	2 550	75	562
	Y0125C	1020 x 720	350g	1050 x 750	1	2 100	75	529
	Y0126C	1020 x 720	400g	1050 x 750	1	1800	50	529
	20626C	1020 x 720	240g	1050 x 750	1	3 000	100	529
	20627C	1020 x 720	300g	1050 x 750	1	2 550	75	562
	20628C	1020 x 720	350g	1050 x 750	1	2 100	75	540
	20629C	1020 x 720	400g	1050 x 750	1	1 800	50	529

STOCKED ENVELOPES **120 gsm**

ADHESIVE ENVELOPES

Ref.	Sizes (mm)	Gsm	Flap	Window	Units / Box	Box / Weight (kg)	Pallet Sizes (mm)	Units / Pallet	Pallet Net Weight (kg)
1482C	DL - 110 x 220	115	adhesive	∅	500	3,65	120 x 80	90	341
1483C	C5 - 162 x 229	115	adhesive	∅	250	2,75	120 x 80	90	260

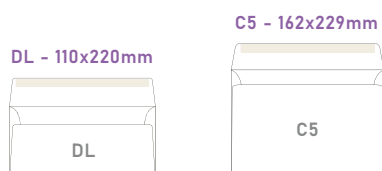



FICHE TECHNIQUE / code 751 TECHNICAL DATA SHEET

	100	130	150	170	240	300
Thickness (µm)	133	173	195	221	305	381
Bulk (cm³/g)	1.33	1.33	1.30	1.30	1.27	1.27
Bendtsen Roughness (ml/min)	245	245	245	245	245	245
Absolute Humidity (%H ₂ O)	5.3	5.3	6.0	6.0	6.5	6.5
Relative Humidity (% in the air)	42	42	48	48	50	50
Opacity (%)	94.5	>99	>99	>99	>99	>99

GAMME RANGE

	100	130	150	170	240	300
 460 x 320 mm	20570C	20571C	20572C	20573C	20574C	20575C



151 CIE



INDIGO ORIGINAL

REBECCA Rock







Indigo Original a été spécialement conçu pour les équipements d'impression numérique à encre liquide HP Indigo. Son traitement de surface spécifique garantit des résultats parfaits tant au niveau qualité d'impression, qu'accrochage de l'encre et absence de pollution sur les machines HP. Sa blancheur équilibrée permet un rendu naturel des couleurs. Il offre les mêmes caractéristiques que les autres papiers Rough et Original. Disponible de 100 g/m² à 300 g/m².

Indigo Original has been designed for the digital printing process of HP Indigo machines. Its specific surface treatment guarantees perfect results, either in printing quality or for ink adhesion and blanket cleanliness on HP machines. Its natural whiteness allows a natural rendition of your coloured prints.

Available from 100 gsm to 300 gsm.



INDIGO ORIGINAL

	Ref.	Sizes (mm)	Gsm	Pallet Sizes (mm)	Stacks	Sheets / Pallet	Tabbed by	Pallet Net Weight (kg)
	20570C	460 x 320	100g	940 x 670	4	28 000	500	412
	20571C	460 x 320	130g	940 x 670	4	22 000	250	421
	20572C	460 x 320	150g	940 x 670	4	20 000	250	442
	20573C	460 x 320	170g	940 x 670	4	19 000	125	475
	20574C	460 x 320	240g	940 x 670	4	12 000	125	424
	20575C	460 x 320	300g	940 x 670	4	10 000	125	442



SILK ORIGINAL



FICHE TECHNIQUE / code 706-570 TECHNICAL DATA SHEET

	100	120	150	170	200	300	350
Thickness (µm)	110	125	152	168	198	297	346
Bulk (cm ³ /g)	1.09	1.07	1.04	1.03	1	0.99	0.99
Bekk Smoothness (s)	120	120	120	120	120	60	60
Absolute Humidity (%H ₂ O)	5.3	5.3	6.0	6.0	6.5	7.0	7.0
Relative Humidity (% in the air)	42	42	48	48	50	60	60
Opacity (%)	93	95	97	98	98	>99	>99

GAMME RANGE

	100	120	150	170	200	300	350
 720 x 1020 mm	5001C	5006C	5011C	5022C	5024C	5025C	5026C
 720 x 1020 mm	5001PC	5006PC	5011PC	5022PC	5024PC	5025PC	5026PC



SILK ORIGINAL















REBECCA Rock

Silk Original reprend les atouts de Rough Original dans une version plus satinée. Il améliore encore le rendu d'impression et offre un toucher plus doux, tout en conservant une très bonne main et tenue. Sa blancheur équilibrée permet un rendu naturel de vos impressions couleurs. Disponible de 100 à 350 g/m².

Silk Original has all the advantages of Rough Original in a more satin finish. It further enhances print rendering and offers a softer touch, while retaining a very good grip and hold. Its well-balanced whiteness ensures a natural rendering of your color prints. Available from 100 to 350 g/m².



SILK ORIGINAL

	Ref.	Sizes (mm)	Gsm	Pallet Sizes (mm)	Stacks	Sheets / Pallet	Tabbed by	Pallet Net Weight (kg)
	5001C	720 x 1020	100g	1050 x 750	1	8 000	250	588
	5006C	720 x 1020	120g	1050 x 750	1	7 000	250	617
	5011C	720 x 1020	150g	1050 x 750	1	5 250	125	578
	5022C	720 x 1020	170g	1050 x 750	1	5 000	125	624
	5024C	720 x 1020	200g	1050 x 750	1	4 500	125	661
	5025C	720 x 1020	300g	1050 x 750	1	3 000	50	661
	5026C	720 x 1020	350g	1050 x 750	1	2 500	50	643
	5001PC	720 x 1020	100g	1050 x 750	1	8 000	250	588
	5006PC	720 x 1020	120g	1050 x 750	1	7 000	250	617
	5011PC	720 x 1020	150g	1050 x 750	1	5 250	125	578
	5022PC	720 x 1020	170g	1050 x 750	1	5 000	125	624
	5024PC	720 x 1020	200g	1050 x 750	1	4 500	125	661
	5025PC	720 x 1020	300g	1050 x 750	1	3 000	50	661
	5026PC	720 x 1020	350g	1050 x 750	1	2 500	50	643

BRUT NATURAL WHITE



FICHE TECHNIQUE / code 816-566 TECHNICAL DATA SHEET

	80	90	100	120	150	200	240	300
Thickness (µm)	120	135	150	180	225	300	360	450
Bulk (cm ³ /g)	1.5	1.5	1.5	1.5	1.5	1.5	1.5	1.5
Bendtsen Roughness (ml/min)	650	650	650	650	650	650	650	650
Absolute Humidity (%H ₂ O)	5.5	5.5	5.5	5.5	6.0	6.0	6.5	6.5
Relative Humidity (% in the air)	44	44	44	44	48	48	55	55
Opacity (%)	94	95	96	>99	>99	>99	>99	>99

GAMME RANGE

	80	90	100	120	150	200	240	300
720 x 1020 mm	4620C	4621C	4622C	4623C	4624C	4636C	4625C	4632C
720 x 1020 mm		4621PC	4622PC	4623PC	4624PC		4625PC	4632PC
1020 x 720 mm	4626C	4627C	4628C	4629C	4630C	4637C	4631C	4633C



120 CIE



BRUT NATURAL WHITE























REBECCA Rock

Affirmez votre singularité avec Brut Natural White. Ce papier au blanc naturel (120 CIE) met en valeur vos créations tout en respectant votre patte. Son grain subtil et son bouffant de 1,5 lui confèrent une texture unique, idéale pour transmettre des valeurs de simplicité et d'élégance discrète. Grâce à son traitement de surface, il garantit une impression de haute qualité et s'adapte aussi bien aux technologies inkjet, laser qu'offset.

Express your individuality with Brut Natural White. This natural white paper (120 CIE) enhances your creations while respecting your style. Its subtle grain and 1.5 bulk give it a unique texture, ideal for conveying the values of simplicity and quiet elegance. Thanks to its surface treatment, it guarantees high-quality printing and is suitable for inkjet, laser and offset technologies.



BRUT NATURAL WHITE

	Ref.	Bulk	Sizes (mm)	Gsm	Pallet Sizes (mm)	Stacks	Sheets / Pallet	Tabbed by	Pallet Net Weight (kg)
	4620C	1,5	720 × 1020	80g	1050 × 750	1	9 000	250	529
	4621C	1,5	720 × 1020	90g	1050 × 750	1	8 000	250	529
	4622C	1,5	720 × 1020	100g	1050 × 750	1	7 000	250	514
	4623C	1,5	720 × 1020	120g	1050 × 750	1	6 000	250	529
	4624C	1,5	720 × 1020	150g	1050 × 750	1	5 000	125	551
	4636C	1,5	720 × 1020	200g	1050 × 750	1	4 000	125	588
	4625C	1,5	720 × 1020	240g	1050 × 750	1	3 000	125	529
	4632C	1,5	720 × 1020	300g	1050 × 750	1	2 500	50	551
	4621PC	1,5	720 × 1020	90g	1050 × 750	1	8 000	250	529
	4622PC	1,5	720 × 1020	100g	1050 × 750	1	7 000	250	514
	4623PC	1,5	720 × 1020	120g	1050 × 750	1	6 000	250	529
	4624PC	1,5	720 × 1020	150g	1050 × 750	1	5 000	125	551
	4625PC	1,5	720 × 1020	240g	1050 × 750	1	3 000	125	529
	4632PC	1,5	720 × 1020	300g	1050 × 750	1	2 500	50	551
	4626C	1,5	1020 × 720	80g	1050 × 750	1	9 000	250	529
	4627C	1,5	1020 × 720	90g	1050 × 750	1	8 000	250	529
	4628C	1,5	1020 × 720	100g	1050 × 750	1	7 000	250	514
	4629C	1,5	1020 × 720	120g	1050 × 750	1	6 000	250	529
	4630C	1,5	1020 × 720	150g	1050 × 750	1	5 000	125	551
	4637C	1,5	1020 × 720	200g	1050 × 750	1	4 000	125	588
	4631C	1,5	1020 × 720	240g	1050 × 750	1	3 000	125	529
	4633C	1,5	1020 × 720	300g	1050 × 750	1	2 500	50	551

ROUGH NATURAL WHITE



FICHE TECHNIQUE / code 852-579 TECHNICAL DATA SHEET

	90	100	120	150	170	200	240	300	350	400
Thickness (µm)	120	133	160	195	221	260	305	381	444	508
Bulk (cm ³ /g)	1.33	1.33	1.33	1.30	1.30	1.30	1.27	1.27	1.27	1.27
Bendtsen Roughness (ml/min)	250	250	250	250	250	250	250	250	300	300
Absolute Humidity (%H ₂ O)	5.6	5.6	5.6	6.0	6.0	6.5	6.5	6.5	7.0	7.0
Relative Humidity (% in the air)	45	45	45	48	48	50	50	50	60	60
Opacity (%)	92	93.5	95	97	98	98	>99	>99	>99	>99

GAMME RANGE

	90	100	120	150	170	200	240	300	350	400
 460 x 640 mm	20103C	20108C	20131C	20132C	20134C	20135C	20136C	20138C	20139C	
 640 x 900 mm		20109C	20113C							
 900 x 640 mm			20114C	20118C						
 720 x 1020 mm	20106C	20111C	20115C	20119C	20121C		20125C	20127C	20140C	20129C
 720 x 1020 mm	20106PC	20111PC	20115PC		20121PC		20125PC	20127PC		
 1020 x 720 mm			20116C	20120C	20122C	20124C	20126C	20128C	20141C	20130C

70



120 CIE



ROUGH NATURAL WHITE







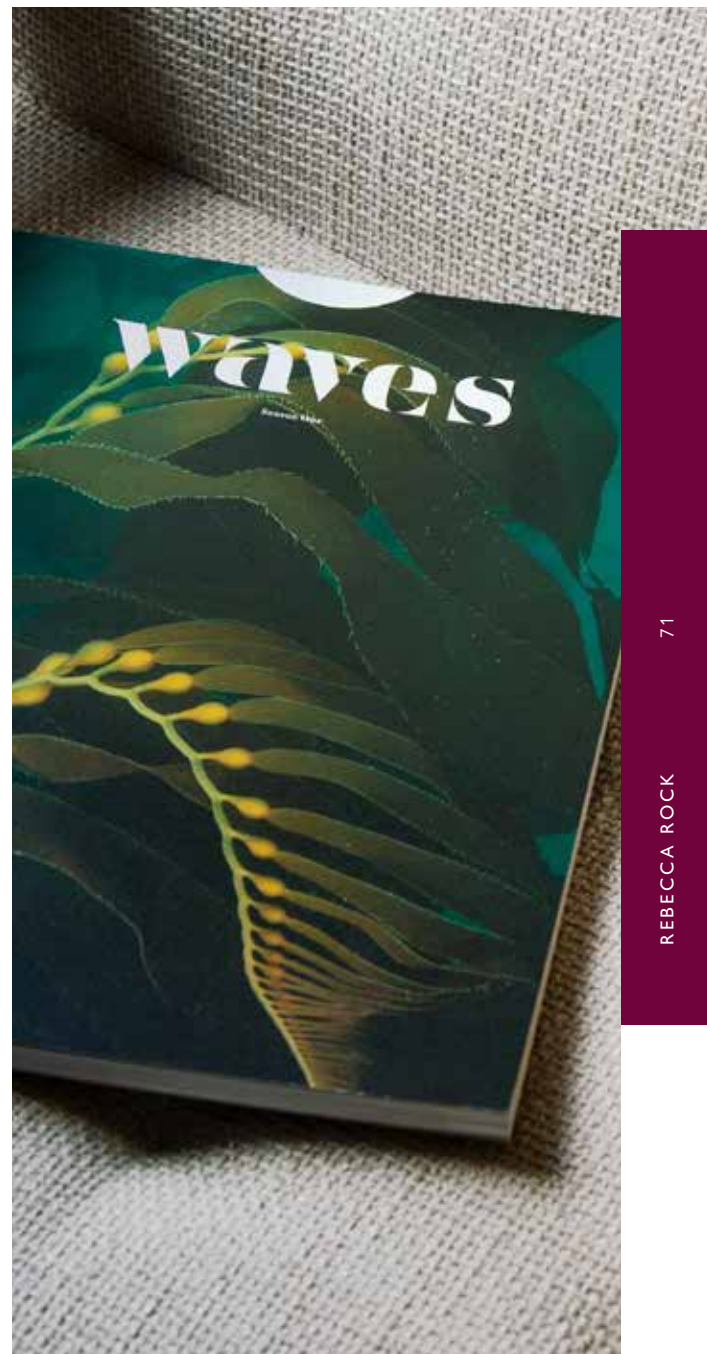





























REBECCA Rock

Rough Natural White est un papier raffiné qui allie finesse, subtilité et caractère. Sa blancheur naturelle (CIE 120) met en valeur vos impressions couleurs en leur offrant un équilibre parfait. Son grain révèle la structure des fibres, apportant une sensation authentique au toucher. Grâce à sa main élevée et à l'homogénéité de sa formation, il constitue un support idéal pour tous vos projets créatifs. Son traitement de surface garantit une excellente compatibilité avec les machines d'impression et assure un rendu net, précis et homogène. Disponible en grammages de 90 g/m² à 400 g/m².

Rough Natural White is a delicate paper that combines elegance, subtlety and character. Its natural whiteness (CIE 120) enhances your colour prints by giving them a perfect balance. Its grain reveals the structure of the fibres, giving an authentic feel to the touch. Its bulk and homogeneous formation make it an ideal base for all your creative projects. Its surface treatment guarantees excellent compatibility with printing machines and ensures a clean, precise and consistent finish. Available in weights from 90 gsm to 400 gsm .





ROUGH NATURAL WHITE

	Ref.	Sizes (mm)	Gsm	Pallet Sizes (mm)	Stacks	Sheets / Pallet	Tabbed by	Pallet Net Weight (kg)
	20103C	460 x 640	90g	940 x 670	2	16 000	500	424
	20108C	460 x 640	100g	940 x 670	2	15 000	500	442
	20131C	460 x 640	120g	940 x 670	2	13 000	250	459
	20132C	460 x 640	150g	940 x 670	2	10 000	250	442
	20134C	460 x 640	170g	940 x 670	2	8 500	250	425
	20135C	460 x 640	200g	940 x 670	2	7 500	250	442
	20136C	460 x 640	240g	940 x 670	2	6 000	125	424
	20138C	460 x 640	300g	940 x 670	2	5 000	125	442
	20139C	460 x 640	350g	940 x 670	2	4 500	125	464
	20109C	640 x 900	100g	920 x 660	1	7 500	250	432
	20113C	640 x 900	120g	920 x 660	1	6 500	250	449
	20114C	900 x 640	120g	920 x 660	1	6 500	250	449
	20118C	900 x 640	150g	920 x 660	1	5 000	125	432
	20106C	720 x 1020	90g	1050 x 750	1	8 000	250	529
	20111C	720 x 1020	100g	1050 x 750	1	7 500	250	551
	20115C	720 x 1020	120g	1050 x 750	1	6 500	250	573
	20119C	720 x 1020	150g	1050 x 750	1	5 000	125	551
	20121C	720 x 1020	170g	1050 x 750	1	4 250	125	531
	20125C	720 x 1020	240g	1050 x 750	1	3 000	100	529
	20127C	720 x 1020	300g	1050 x 750	1	2 550	75	562
	20140C	720 x 1020	350g	1050 x 750	1	2 100	75	540
	20129C	720 x 1020	400g	1050 x 750	1	1 800	50	529
	20106PC	720 x 1020	90g	1050 x 750	1	8 000	250	529
	20111PC	720 x 1020	100g	1050 x 750	1	7 500	250	551
	20115PC	720 x 1020	120g	1050 x 750	1	6 500	250	573
	20121PC	720 x 1020	170g	1050 x 750	1	4 250	125	531
	20125PC	720 x 1020	240g	1050 x 750	1	3 000	100	529
	20127PC	720 x 1020	300g	1050 x 750	1	2 550	75	562
	20116C	1020 x 720	120g	1050 x 750	1	6 500	250	573
	20120C	1020 x 720	150g	1050 x 750	1	5 000	125	551
	20122C	1020 x 720	170g	1050 x 750	1	4 250	125	531
	20124C	1020 x 720	200g	1050 x 750	1	3 750	125	551
	20126C	1020 x 720	240g	1050 x 750	1	3 000	100	529
	20128C	1020 x 720	300g	1050 x 750	1	2 550	75	562
	20141C	1020 x 720	350g	1050 x 750	1	2 100	75	540
	20130C	1020 x 720	400g	1050 x 750	1	1 800	50	529

FICHE TECHNIQUE / code 762-553 TECHNICAL DATA SHEET

	90	120	150	200	300	400
Thickness (µm)	131	174	218	280	420	560
Bulk (cm ³ /g)	1.45	1.45	1.45	1.40	1.40	1.40
Bendtsen Roughness (ml/min)	550	550	550	550	550	750
Absolute Humidity (%H ₂ O)	5.0	5.0	6.0	6.5	6.5	7.0
Relative Humidity (% in the air)	38	38	48	50	50	60
Opacity (%)	90	95	>99	>99	>99	>99

GAMME RANGE

	90	120	150	200	300	400
 720 x 1020 mm	4401C	4402C	4403C	4404C	4405C	4413C
 720 x 1020 mm	4401PC	4402PC	4403PC	4404PC	4405PC	
 1020 x 720 mm	4406C	4407C	4408C	4409C	4410C	4414C



BRUT NATURAL

REBECCA Rock

A la recherche d'un papier authentique, à la personnalité affirmée ? Et si vous optiez pour Brut Natural ? Outre les caractéristiques techniques de sa famille, rugosité forte, main élevée, surface pigmentée pour un rendu d'impression de qualité, Brut Natural possède surtout, une teinte chaude et vive, obtenue sans agent fluorescent. Cette singularité lui confère un charme discret aux notes variées, pour s'adapter à toutes les applications, revues, catalogues, beaux livres...

A explorer sans retenue !

Disponible de 90 g/m² à 400 g/m².

















Looking for an authentic paper with a strong personality? Why not choose Brut Natural? In addition to the technical characteristics of its family, high roughness, high hand, pigmented surface for a quality printing result, Brut Natural has above all, a warm and vivid tint, obtained without fluorescent agents. This singularity gives it a discreet charm with varied notes, to adapt to all applications, magazines, catalogues, fine books...

To be explored without restraint!

Available from 90 gsm to 400 gsm.



BRUT NATURAL

	Ref.	Sizes (mm)	Gsm	Pallet Sizes (mm)	Stacks	Sheets / Pallet	Tabbed by	Pallet Net Weight (kg)
	4401C	720 x 1020	90g	1050 x 750	1	9 000	250	595
	4402C	720 x 1020	120g	1050 x 750	1	6 500	250	573
	4403C	720 x 1020	150g	1050 x 750	1	5 000	125	551
	4404C	720 x 1020	200g	1050 x 750	1	4 000	125	588
	4405C	720 x 1020	300g	1050 x 750	1	2 500	50	551
	4413C	720 x 1020	400g	1050 x 750	1	1800	50	529
	4401PC	720 x 1020	90g	1050 x 750	1	9 000	250	595
	4402PC	720 x 1020	120g	1050 x 750	1	6 500	250	573
	4403PC	720 x 1020	150g	1050 x 750	1	5 000	125	551
	4404PC	720 x 1020	200g	1050 x 750	1	4 000	125	588
	4405PC	720 x 1020	300g	1050 x 750	1	2 500	50	551
	4406C	1020 x 720	90g	1050 x 750	1	9 000	250	595
	4407C	1020 x 720	120g	1050 x 750	1	6 500	250	573
	4408C	1020 x 720	150g	1050 x 750	1	5 000	125	551
	4409C	1020 x 720	200g	1050 x 750	1	4 000	125	588
	4410C	1020 x 720	300g	1050 x 750	1	2 500	50	551
	4414C	1020 x 720	400g	1050 x 750	1	1800	50	529

ROUGH NATURAL



FICHE TECHNIQUE / code 708/532 TECHNICAL DATA SHEET

	80	90	100	120	130	150	170	200	240	300	350	400
Thickness (µm)	106	120	133	160	169	195	221	260	305	381	444	508
Bulk (cm³/g)	1.33	1.33	1.33	1.33	1.30	1.30	1.30	1.30	1.27	1.27	1.27	1.27
Bendtsen Roughness (ml/min)	200	200	200	200	200	200	200	200	200	200	300	300
Absolute Humidity (%H ₂ O)	4.6	4.6	5.0	5.5	5.5	6.0	6.0	6.5	6.5	6.5	7.0	7.0
Relative Humidity (% in the air)	32	32	38	44	44	44	44	48	48	50	60	60
Opacity (%)	88	90	91	95	>99	>99	>99	>99	>99	>99	>99	>99

GAMME RANGE

	80	90	100	120	130	150	170	200	240	300	350	400
450 x 320 mm			Y3030C									
460 x 640 mm		20503C	20504C		20505C	20506C	20539C	20507C	20508C	20509C		
460 x 640 mm	5014C	Y0149C	Y0150C	3333C	Y0151C	Y0152C	Y0153C	Y0154C	Y0173C	Y0174C		
640 x 900 mm			20545C									
640 x 900 mm			Y0155C		Y0156C	Y0157C	Y0158C					
900 x 640 mm					20546C							
900 x 640 mm			Y0159C		Y0160C	Y0161C						
650 x 920 mm			5023C									
720 x 1020 mm		20525C	20526C		20527C	20528C	20529C	20530C	20531C	20532C	20533C	5019C
720 x 1020 mm	5015C	3340C	Y0168C	3343C	Y0169C	Y0170C						
1020 x 720 mm		20540C			20541C	20542C			20543C	20544C		
1020 x 720 mm			5017C	5020C		5021C						

STOCKED ENVELOPES

CF. Page 81



ROUGH NATURAL

REBECCA Rock

Le support nature par excellence.

Rough Natural, c'est en premier lieu une teinte chaude et subtile. Produit sans agent fluorescent, Rough Natural est un support idéal pour restituer l'équilibre des couleurs et garantir une balance chromatique parfaite.

Sa surface régulière, sa formation de feuille parfaite et sa rigidité élevée vous assurent une excellente aptitude à la transformation.

Vos documents seront agréables à lire et à tenir en main.

Rough Natural est compatible avec les techniques d'impression offset, jet d'encre et laser.

Disponible de 80 g/m² à 400 g/m².

The ultimate, natural medium Rough Natural is first and foremost a warm and subtle shade. Produced without bleaching agents (OBA), Rough Natural is an ideal substrate to guarantee a perfect chromatic balance.

Its smooth surface, perfect sheet formation and high rigidity ensure an excellent processability.

Your documents will be pleasant to read and hold.

Rough Natural is compatible with offset, inkjet and laser printing techniques.

Available from 80 gsm to 400 gsm.



ROUGH NATURAL

	Ref.	Sizes (mm)	Gsm	Pallet Sizes (mm)	Stacks	Sheets / Pallet	Tabbed by	Pallet Net Weight (kg)
	Y3030C	450 x 320	100g	940 x 670	4	28 000	250	403
	20503C	460 x 640	90g	940 x 670	2	16 000	500	424
	20504C	460 x 640	100g	960 x 690	2	15 000	500	442
	20505C	460 x 640	130g	960 x 690	2	11 000	250	421
	20506C	460 x 640	150g	960 x 690	2	10 000	250	442
	20539C	460 x 640	170g	960 x 690	2	8 500	250	425
	20507C	460 x 640	200g	960 x 690	2	7 500	250	442
	20508C	460 x 640	240g	960 x 690	2	6 000	125	424
	20509C	460 x 640	300g	960 x 690	2	5 000	125	442
	5014C	460 x 640	80g	940 x 670	2	18 000	500	424
	Y0149C	460 x 640	90g	940 x 670	2	16 000	500	424
	Y0150C	460 x 640	100g	940 x 670	2	15 000	500	442
	3333C	460 x 640	120g	940 x 670	2	13 000	250	459
	Y0151C	460 x 640	130g	940 x 670	2	11 000	250	421
	Y0152C	460 x 640	150g	940 x 670	2	10 000	250	442
	Y0153C	460 x 640	170g	940 x 670	2	8 500	250	425
	Y0154C	460 x 640	200g	940 x 670	2	7 500	250	442
	Y0173C	460 x 640	240g	940 x 670	2	6 000	125	424
	Y0174C	460 x 640	300g	940 x 670	2	5 000	125	442
	20545C	640 x 900	100g	940 x 670	1	7 500	250	432
	Y0155C	640 x 900	100g	940 x 670	1	7 500	250	432
	Y0156C	640 x 900	130g	940 x 670	1	5 500	250	412
	Y0157C	640 x 900	150g	940 x 670	1	5 000	125	432
	Y0158C	640 x 900	170g	940 x 670	1	4 250	125	416
	20546C	900 x 640	130g	940 x 670	1	5 500	250	412
	Y0159C	900 x 640	100g	940 x 670	1	7 500	250	432
	Y0160C	900 x 640	130g	940 x 670	1	5 500	250	412
	Y0161C	900 x 640	150g	940 x 670	1	5 000	125	432
	5023SC	650 x 920	100g	940 x 670	2	7 500	250	432
	20525C	720 x 1020	90g	1050 x 750	2	8 000	250	529
	20526C	720 x 1020	100g	1050 x 750	2	7 500	250	551
	20527C	720 x 1020	130g	1050 x 750	1	5 400	200	518
	20528C	720 x 1020	150g	1050 x 750	1	5 000	125	551

ROUGH NATURAL

	Ref.	Sizes (mm)	Gsm	Pallet Sizes (mm)	Stacks	Sheets / Pallet	Tabbed by	Pallet Net Weight (kg)
	20529C	720 x 1020	170g	1050 x 750	1	4 250	125	531
	20530C	720 x 1020	200g	1050 x 750	1	3 750	125	551
	20531C	720 x 1020	240g	1050 x 750	1	3 000	100	529
	20532C	720 x 1020	300g	1050 x 750	1	2 550	75	562
	20533C	720 x 1020	350g	1050 x 750	1	2 100	75	540
	5019C	720 x 1020	400g	1050 x 750	1	1 800	50	529
	5015C	720 x 1020	80g	1050 x 750	1	9 000	250	529
	3340C	720 x 1020	90g	1050 x 750	1	8 000	250	529
	Y0168C	720 x 1020	100g	1050 x 750	1	7 500	250	551
	3343C	720 x 1020	120g	1050 x 750	1	6 500	250	573
	Y0169C	720 x 1020	130g	1050 x 750	1	5 400	200	516
	Y0170C	720 x 1020	150g	1050 x 750	1	5 000	125	551
	20540C	1020 x 720	90g	1050 x 750	1	8 000	250	529
	5017C	1020 x 720	100g	1050 x 750	1	7 500	250	432
	5020C	1020 x 720	120g	1050 x 750	1	6 500	250	573
	5021C	1020 x 720	150g	1050 x 750	1	5 000	125	551
	20541C	1020 x 720	130g	1050 x 750	1	5 400	200	516
	20542C	1020 x 720	150g	1050 x 750	1	5 000	125	551
	20543C	1020 x 720	240g	1050 x 750	1	3 000	100	529
	20544C	1020 x 720	300g	1050 x 750	1	2 550	75	562

STOCKED ENVELOPES **120 gsm**

ADHESIVE ENVELOPES

Ref.	Sizes (mm)	Gsm	Flap	Window	Units / Box	Box / Weight (kg)	Pallet Sizes (mm)	Units / Pallet	Pallet Net Weight (kg)
1484C	DL - 110 x 220	120	adhesive	∅	500	3,65	120 x 80	90	341
1485C	C5 - 162 x 229	120	adhesive	∅	250	2,75	120 x 80	90	260

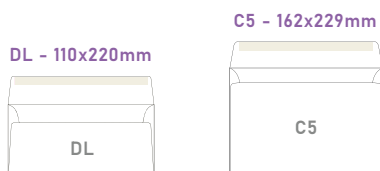

SILK NATURAL



FICHE TECHNIQUE / code 824 TECHNICAL DATA SHEET

	100	240	300
Thickness (µm)	110	238	297
Bulk (cm ³ /g)	1.1	0.99	0.99
Bekk Smoothness (s)	120	120	60
Absolute Humidity (%H ₂ O)	5.3	6.5	7.0
Relative Humidity (% in the air)	42	50	60
Opacity (%)	91	>99	>99

GAMME RANGE

	100	240	300
 1020 x 720 mm	5045C	5046C	5047C



SILK NATURAL

REBECCA Rock

Silk Natural offre l'élégance d'un papier naturel avec un toucher soyeux encore plus doux et une surface agréable et veloutée. Sa teinte douce et naturelle, obtenue sans agent fluorescent, confère aux impressions un rendu harmonieux et naturel, particulièrement valorisant pour les couleurs et les visuels sensibles.

Le rendu d'impression et la brillance d'encre se rapprochent de ceux d'un papier couché, tout en conservant l'aspect et la sensation d'un papier naturel.

Son excellent épair et sa très bonne main garantissent une parfaite tenue ainsi qu'une restitution fidèle des détails.

Disponible de 100g/m² à 300g/m².

Domaines d'utilisation : rapports d'activité, brochures et éditions haut de gamme, communication institutionnelle, cartes de visite, cartes de correspondance et supports valorisant une image naturelle et élégante.

Silk Natural offers the elegance of a natural paper with an even softer silky touch and a smooth, velvety surface. Its soft, natural tone, achieved without fluorescent whitening agents, provides a harmonious and natural rendering of colour prints, particularly enhancing delicate images and subtle visuals. Print quality and ink brilliance are comparable to those of a coated paper, while preserving the look and feel of a natural paper.



Its excellent formation and very good stiffness ensure perfect runnability and faithful reproduction of fine details.

Available from 100g/m² to 300g/m².

Areas of application: annual reports, high-quality brochures and publications, corporate communication, business cards, correspondence cards and all media requiring a natural and elegant appearance.



SILK NATURAL

	Ref.	Sizes (mm)	Gsm	Pallet Sizes (mm)	Stacks	Sheets / Pallet	Tabbed by	Pallet Net Weight (kg)
	5045C	720 × 1020	100g	1050 × 750	1	8000	250	588
	5046C	720 × 1020	240g	1050 × 750	1	4000	125	705
	5047C	720 × 1020	300g	1050 × 750	1	3000	50	661

CLAIRBOOK 1.5 EXTRA WHITE
CLAIRBOOK 1.5 - 1.8 - 2.0 NATURAL WHITE
CLAIRBOOK 1.5 - 1.8 - 2.0 IVORY



REBECCA Bulk



CLAIRBOOK 1.5
EXTRA WHITE





FICHE TECHNIQUE / code 790/565 TECHNICAL DATA SHEET

	80	90	100	120	150	240	300
Thickness (µm)	120	135	150	180	225	350	450
Bulk (cm ³ /g)	1.5	1.5	1.5	1.5	1.5	1.5	1.5
Bendtsen Roughness (ml/min)	650	650	650	650	650	650	650
Absolute Humidity (%H ₂ O)	5.5	5.5	5.5	5.5	6.0	5.5	5.5
Relative Humidity (% in the air)	44	44	44	44	44	44	44
Opacity (%)	94	95	96	>99	>99	>99	>99

88

GAMME RANGE

	80	90	100	120	150	240	300
 720 x 1020 mm	4607C	4608C	4609C	4610C	4611C	4606C	4634C
 720 x 1020 mm	4607PC	4608PC	4609PC	4610PC	4611PC	4606PC	4634PC
 1020 x 720 mm	4613C	4614C	4615C	4616C	4617C	4612C	4635C



150 CIE



CLAIRBOOK 1.5 EXTRA WHITE





















REBECCA Bulk

Clairbook 1.5 Extra White, véritablement unique, est le support idéal pour des illustrations ou brochures haut de gamme. En effet, ce papier bénéficie d'une formulation spécifique qui conjugue, une blancheur supérieure de 150 CIE, une main idéale de 1.5 et une enduction spéciale, pour un rendu d'impression sans pareil. Polyvalent, ce papier s'imprime dans de nombreuses technologies d'impression. Disponible de 80 g/m² à 300 g/m².

Clairbook 1.5 Extra White is a truly unique paper that is ideal for high-end illustrations or brochures. This paper has been specially formulated to combine a superior whiteness of 150 CIE, an ideal bulk of 1.5, and a special coating for an unrivalled print result. Versatile, this paper can be printed on a wide range of printing technologies. Available from 80 gsm to 300 gsm.



CLAIRBOOK 1.5 EXTRA WHITE

	Ref.	Bulk	Sizes (mm)	Gsm	Pallet Sizes (mm)	Stacks	Sheets / Pallet	Tabbed by	Pallet Net Weight (kg)
	4607C	1,5	720 x 1020	80g	1050 x 750	1	9 000	250	529
	4608C	1,5	720 x 1020	90g	1050 x 750	1	8 000	250	529
	4609C	1,5	720 x 1020	100g	1050 x 750	1	7 000	250	514
	4610C	1,5	720 x 1020	120g	1050 x 750	1	6 000	250	529
	4611C	1,5	720 x 1020	150g	1050 x 750	1	5 000	125	551
	4606C	1,5	720 x 1020	240g	1050 x 750	1	3 000	125	529
	4634C	1,5	720 x 1020	300g	1050 x 750	1	2 500	50	551
	4607PC	1,5	720 x 1020	80g	1050 x 750	1	9 000	250	529
	4608PC	1,5	720 x 1020	90g	1050 x 750	1	8 000	250	529
	4609PC	1,5	720 x 1020	100g	1050 x 750	1	7 000	250	514
	4610PC	1,5	720 x 1020	120g	1050 x 750	1	6 000	250	529
	4611PC	1,5	720 x 1020	150g	1050 x 750	1	5 000	125	551
	4606PC	1,5	720 x 1020	240g	1050 x 750	1	3 000	125	529
	4634PC	1,5	720 x 1020	300g	1050 x 750	1	2 500	50	551
	4613C	1,5	1020 x 720	80g	1050 x 750	1	9 000	250	529
	4614C	1,5	1020 x 720	90g	1050 x 750	1	8 000	250	529
	4615C	1,5	1020 x 720	100g	1050 x 750	1	7 000	250	514
	4616C	1,5	1020 x 720	120g	1050 x 750	1	6 000	250	529
	4617C	1,5	1020 x 720	150g	1050 x 750	1	5 000	125	551
	4612C	1,5	1020 x 720	240g	1050 x 750	1	3 000	125	529
	4635C	1,5	1020 x 720	300g	1050 x 750	1	2 500	50	551

CLAIRBOOK 1.5 - 1.8 - 2.0
NATURAL WHITE



FICHE TECHNIQUE / code 816-566 TECHNICAL DATA SHEET

	1.5							
	80	90	100	120	150	200	240	300
Thickness (µm)	120	135	150	180	225	300	360	450
Bulk (cm ³ /g)	1.5	1.5	1.5	1.5	1.5	1.5	1.5	1.5
Bendtsen Roughness (ml/min)	650	650	650	650	650	650	650	650
Absolute Humidity (%H ₂ O)	5.5	5.5	5.5	5.5	6.0	6.0	6.5	6.5
Relative Humidity (% in the air)	44	44	44	44	48	48	55	55
Opacity (%)	94	95	96	>99	>99	>99	>99	>99

code 188-0371	1.8			2.0
	70	80	90	80
Thickness (µm)	127	145	164	160
Bulk (cm ³ /g)	1.81	1.81	1.82	2.0
Bendtsen Roughness (ml/min)	650	650	650	750
Absolute Humidity (%H ₂ O)	5.0	5.0	5.0	5.0
Relative Humidity (% in the air)	38	38	38	38
Opacity (%)	93	93	91	91.5

GAMME RANGE

		70	80	90	100	120	150	200	240	300
1.5	720 x 1020 mm		4620C	4621C	4622C	4623C	4624C	4636C	4625C	4632C
	720 x 1020 mm		4620PC	4621PC	4622PC	4623PC	4624PC	4636PC	4625PC	4632PC
	1020 x 720 mm		4626C	4627C	4628C	4629C	4630C	4637C	4631C	4633C
1.8	320 x 450 mm		3732C							
	320 x 460 mm		3735C							
	650 x 920 mm	3604C	3730C							
	720 x 1020 mm		3729C	3743C						
	720 x 1020 mm		3729PC	3743PC						
	900 x 640 mm			3746C						
	1020 x 720 mm		3760C	3747C						
2.0	650 x 920 mm		3750C							
	720 x 1020 mm		3753C							



120 CIE



1.5



1.8

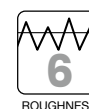

2.0

CLAIRBOOK 1.5 - 1.8 - 2.0 NATURAL WHITE







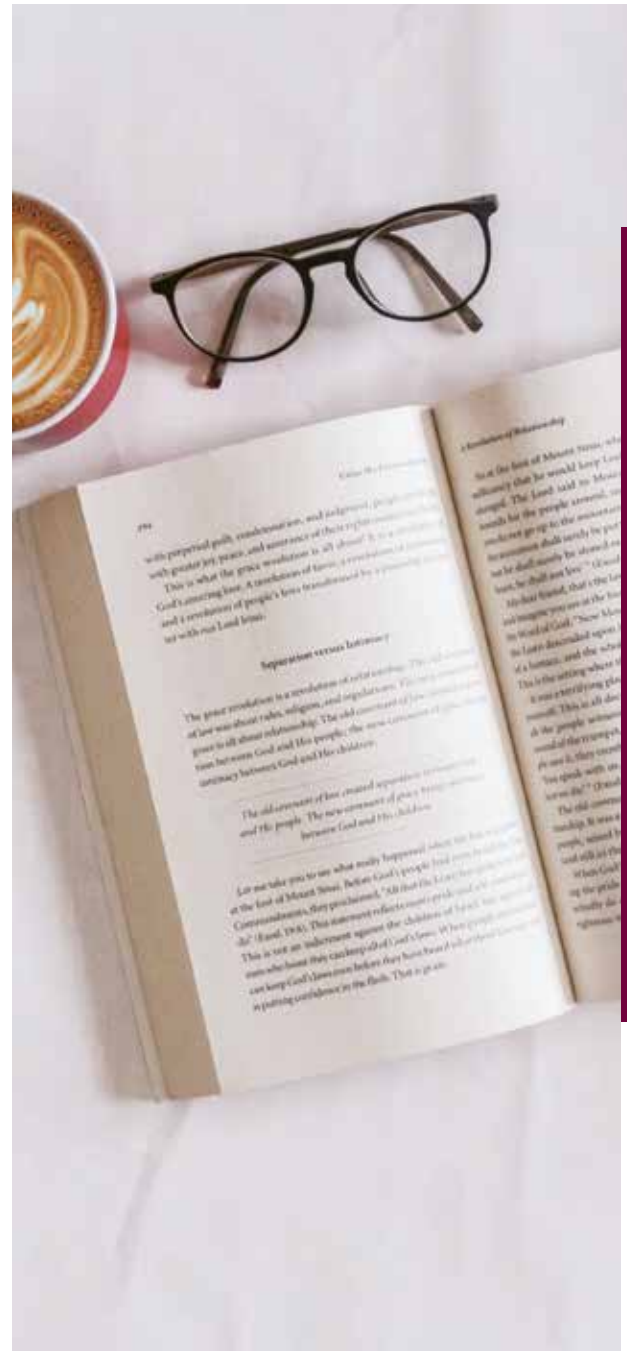

REBECCA Bulk

Jouez la carte de la différence avec Clairbook Natural White, dont la blancheur de 120 CIE est parfaite pour promouvoir vos créations et véhiculer une image chaleureuse. Ce papier, non couché, au toucher authentique saura transmettre les valeurs de simplicité et de sobriété, recherchées actuellement. Disponible en main de 1.5, 1.8 ou 2.0, Clairbook Natural White dispose, en surface, d'une enduction qui améliore considérablement le rendu d'impression et lui permet d'être imprimé aussi bien en inkjet, laser et offset.

Set yourself apart with Clairbook Natural White, whose 120 CIE whiteness is perfect for promoting your creations and giving a warm image. This uncoated paper, with an authentic feel and will convey the values of simplicity and sobriety currently favoured. Available in bulks 1.5, 1.8 or 2.0, Clairbook Natural White has a surface coating which considerably improves the print result and allows it to be used for both inkjet, laser, and offset production.













CLAIRBOOK 1.5 - 1.8 - 2.0
NATURAL WHITE

Ref.	Bulk	Sizes (mm)	Gsm	Pallet Sizes (mm)	Stacks	Sheets / Pallet	Tabbed by	Pallet Net Weight (kg)
CLAIRBOOK 1.5 NATURAL WHITE								
 4620C	1,5	720 x 1020	80g	1050 x 750	1	9 000	250	529
 4621C	1,5	720 x 1020	90g	1050 x 750	1	8 000	250	529
 4622C	1,5	720 x 1020	100g	1050 x 750	1	7 000	250	514
 4623C	1,5	720 x 1020	120g	1050 x 750	1	6 000	250	529
 4624C	1,5	720 x 1020	150g	1050 x 750	1	5 000	125	551
 4636C	1,5	720 x 1020	200g	1050 x 750	1	4 000	125	588
 4625C	1,5	720 x 1020	240g	1050 x 750	1	3 000	125	529
 4632C	1,5	720 x 1020	300g	1050 x 750	1	2 500	50	551
 4620PC	1,5	720 x 1020	80g	1050 x 750	1	9 000	250	529
 4621PC	1,5	720 x 1020	90g	1050 x 750	1	8 000	250	529
 4622PC	1,5	720 x 1020	100g	1050 x 750	1	7 000	250	514
 4623PC	1,5	720 x 1020	120g	1050 x 750	1	6 000	250	529
 4624PC	1,5	720 x 1020	150g	1050 x 750	1	5 000	125	551
 4636PC	1,5	720 x 1020	200g	1050 x 750	1	4 000	125	588
 4625PC	1,5	720 x 1020	240g	1050 x 750	1	3 000	125	529
 4632PC	1,5	720 x 1020	300g	1050 x 750	1	2 500	50	551
 4626C	1,5	1020 x 720	80g	1050 x 750	1	9 000	250	529
 4627C	1,5	1020 x 720	90g	1050 x 750	1	8 000	250	529
 4628C	1,5	1020 x 720	100g	1050 x 750	1	7 000	250	514
 4629C	1,5	1020 x 720	120g	1050 x 750	1	6 000	250	529
 4630C	1,5	1020 x 720	150g	1050 x 750	1	5 000	125	551
 4637C	1,5	1020 x 720	200g	1050 x 750	1	4 000	125	588
 4631C	1,5	1020 x 720	240g	1050 x 750	1	3 000	125	529
 4633C	1,5	1020 x 720	300g	1050 x 750	1	2 500	50	551



CLAIRBOOK 1.5 - 1.8 - 2.0
NATURAL WHITE

Ref.	Bulk	Sizes (mm)	Gsm	Pallet Sizes (mm)	Stacks	Sheets / Pallet	Tabbed by	Pallet Net Weight (kg)
------	------	------------	-----	-------------------	--------	-----------------	-----------	------------------------

CLAIRBOOK 1.8 NATURAL WHITE

 3604C	1.8	650 x 920	70g	960 x 6970	1	8 500	250	356
 3732C	1.8	320 x 450	80g	940 x 670	4	32 000	500	369
 3735C	1.8	320 x 460	80g	670 x 940	4	28000	500	320
 3730C	1.8	650 x 920	80g	940 x 670	1	7 500	250	359
 3729C	1.8	720 x 1020	80g	1050 x 750	1	7 500	250	441
 3743C	1.8	720 x 1020	90g	1050 x 750	1	6 500	250	430
 3729PC	1.8	720 x 1020	80g	1050 x 750	1	7 500	250	441
 3743PC	1.8	720 x 1020	90g	1050 x 750	1	6 500	250	430
 3746C	1.8	900 x 640	90g	920 x 660	2	6 500	250	337
 3760C	1.8	1020 x 720	80g	1050 x 750	1	7 500	250	441
 3747C	1.8	1020 x 720	90g	1050 x 750	1	6 500	250	430

CLAIRBOOK 2.0 NATURAL WHITE

 3750C	2.0	650 x 920	80g	940 x 670	1	7 500	250	359
 3753C	2.0	720 x 1020	80g	1050 x 750	1	7 500	250	441

CLAIRBOOK 1.5 - 1.8 - 2.0
IVORY



FICHE TECHNIQUE / code 059/189/728 TECHNICAL DATA SHEET

	1.5		1.8		2.0	
	80	90	80	90	80	90
Thickness (µm)	122	137	148	167	160	180
Bulk (cm ³ /g)	1.53	1.52	1.85	1.86	2.0	2.0
Bendtsen Roughness (ml/min)	240	240	650	650	750	750
Absolute Humidity (%H ₂ O)	5.0	5.0	5.0	5.0	5.0	5.0
Relative Humidity (% in the air)	38	38	38	38	38	38
Opacity (%)	91.5	93.5	91	93	91.5	92.5



GAMME RANGE

IVORY		80	90
1.5	640 x 900 mm	3770C	3771C
	720 x 1020 mm	3706C	
	1020 x 720 mm		3775C
1.8	320 x 450 mm	3603C	3768C
	650 x 920 mm	3779C	
	720 x 1020 mm	3699C	3776C
	720 x 1020 mm	3699PC	3776PC
	1020 x 720 mm	3765C	
2.0	320 x 450 mm	3757C	
	650 x 920 mm	3758C	
	720 x 1020 mm	3759C	3762C



CLAIRBOOK 1.5 - 1.8 - 2.0 IVORY

REBECCA Bulk

La gamme Clairbook est également proposée dans une élégante teinte ivoire. Offrant les mêmes propriétés techniques et la polyvalence que Clairbook Natural White, vous pourrez l'appliquer en procédé d'impression jet d'encre, laser, offset. Il saura ainsi répondre à toutes les quantités de tirages.



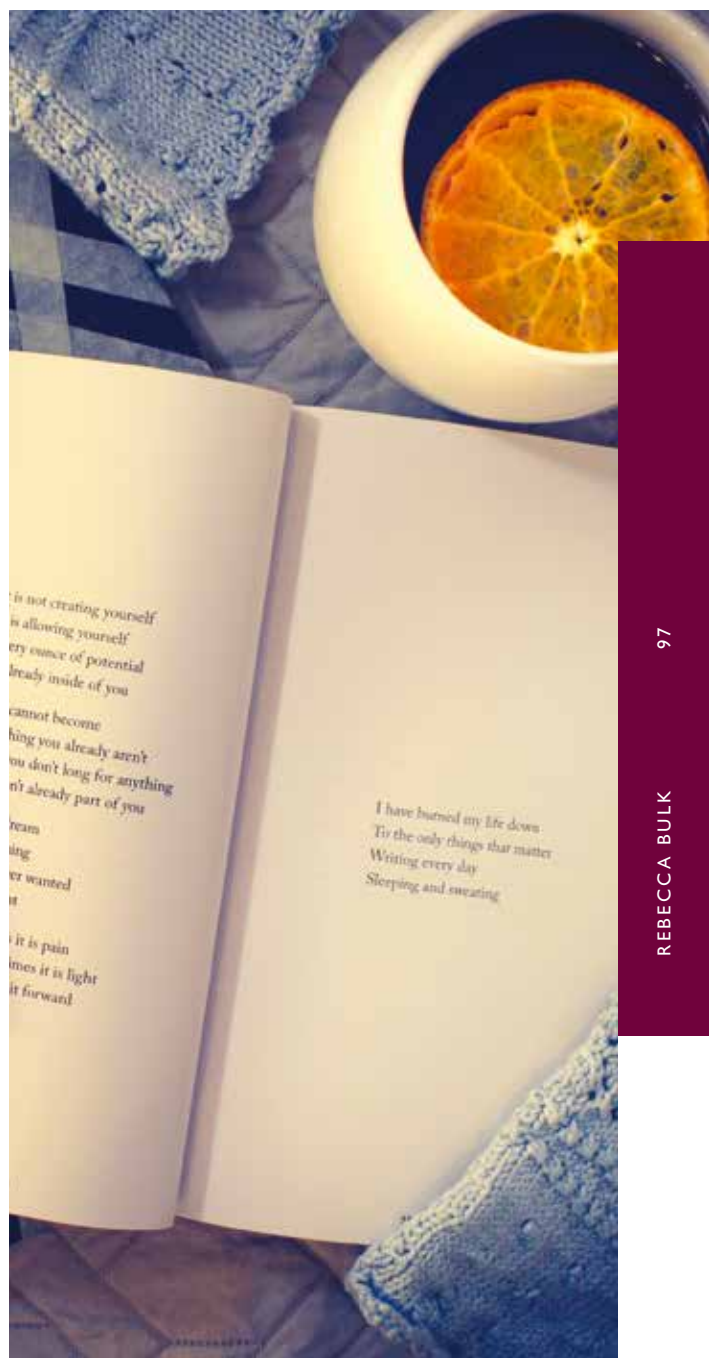

The Clairbook range is also available with an elegant ivory shade. As it offers same properties as Clairbook Natural White, you may use it on inkjet, laser or offset printing machines. It will thus meet with all printing run sizes.











CLAIRBOOK 1.5 - 1.8 - 2.0
IVORY

Ref.	Bulk	Sizes (mm)	Gsm	Pallet Sizes (mm)	Stacks	Sheets / Pallet	Tabbed by	Pallet Net Weight (kg)
------	------	------------	-----	-------------------	--------	-----------------	-----------	------------------------





CLAIRBOOK 1.5 IVORY

 3770C	1.5	640 × 900	80g	920 × 660	1	9 000	250	415
 3771C	1.5	640 × 900	90g	920 × 660	1	8 000	250	415
 3706C	1.5	720 × 1020	80g	1050 × 750	1	9 000	250	529
 3775C	1.5	1020 × 720	90g	1050 × 750	1	8 000	250	529

CLAIRBOOK 1.8 IVORY

 3603C	1.8	320 × 450	80g	940 × 670	4	32 000	500	369
 3779C	1.8	650 × 920	80g	940 × 670	1	7 500	250	359
 3699C	1.8	720 × 1020	80g	1050 × 750	1	7 500	250	441
 3776C	1.8	720 × 1020	90g	1050 × 750	1	6 500	250	430
 3699PC	1.8	720 × 1020	80g	1050 × 750	1	7 500	250	441
 3776PC	1.8	720 × 1020	90g	1050 × 750	1	6 500	250	430
 3765C	1.8	1020 × 720	80g	1050 × 750	1	7 500	250	441
 3768C	1.8	320 × 450	90g	940 × 670	4	28 000	500	363

CLAIRBOOK 2.0 IVORY

 3757C	2.0	320 × 450	80g	940 × 670	4	30 000	500	346
 3758C	2.0	650 × 920	80g	940 × 670	1	7 500	250	359
 3759C	2.0	720 × 1020	80g	1050 × 750	1	7 500	250	441
 3762C	2.0	720 × 1020	90g	1050 × 750	1	6 500	250	430

SUBLIM BRIGHT
LIFE SUBLIM



REBECCA Sublim





SUBLIM BRIGHT

FICHE TECHNIQUE / code 734/077/509 TECHNICAL DATA SHEET

	80	90	100	120	150	170	200	240	300	400
Thickness (µm)	101	113	123	148	184	209	239	295	362	486
Bulk (cm³/g)	1.26	1.26	1.23	1.23	1.23	1.23	1.23	1.23	1.21	1.21
Bendtsen Roughness (ml/min)	200	200	200	200	200	200	200	200	160	160
Absolute Humidity (%H ₂ O)	5.0	5.0	5.0	5.5	6.0	6.0	6.0	6.0	7.0	7.0
Relative Humidity (% in the air)	38	38	38	44	44	44	48	48	60	60
Opacity (%)	96	98	96	98	99	>99	>99	>99	>99	>99

GAMME RANGE

	80	90	100	120	150	170	200	240	300	400
 460 x 640 mm			3972C	3973C	3974C	3975C	3976C	3977C	3194C	
 650 x 920 mm	3986C	3987C	3988C	3989C	3990SC	3991C	3992C	3993C	3170C	
 920 x 650 mm	3978C		3909C	3927C	3911SC	3913C	3928C	3173C	3824C	
 700 x 1000 mm	3189C	3174C	3175C	3176C	3179C	3180C	3181C	3182C	3171C	3196C
 1000 x 700 mm	3901C	3917C	3918C	3183C	3920C	3184C	3926C	3185C	3172C	3197C



SUBLIM BRIGHT

REBECCA Sublim

Pour des catalogues illustrés ou des beaux livres, le réflexe habituel des graphistes est de choisir des papiers couchés. Les papiers offset non-couchés étaient souvent réservés à des publications ayant un caractère naturel ou traditionnel. Avec Sublim Bright s'ouvre une nouvelle voie pour l'industrie graphique. Grâce à la technologie Clairtech, cette génération de papier de classe supérieure redéfinit entièrement l'impression polychrome sur papier nature, offrant une reproduction parfaite des images. Une consommation d'encre minimale et d'excellentes aptitudes en machine, avec des temps de séchage courts, offrent les meilleures conditions pour un façonnage rapide et augmentent donc la productivité. Sublim est parfait pour les impressions multiples à fort taux d'encre, ainsi que pour des finitions variées (gaufrage, dorure, embossage, vernis, pelliculage...).

Il offre une aptitude excellente au rainage et au pliage.

Domaines d'utilisation : rapports d'activité, livres d'art, brochures et publicité de haute qualité.

Disponible de 80 g/m² à 400 g/m².

For illustrated catalogues or beautiful books, graphic designers would usually choose coated papers. Offset or natural papers were often reserved for publications with a natural or traditional character.

With Sublim Bright, a new way in the graphic industry gets open. Thanks to Clairtech technology, this generation of premium paper completely redefines polychrome printing on uncoated paper, offering perfect image reproduction on a paper with a natural feel.

A minimal ink consumption and excellent printing capabilities, together with short drying times, offer the best conditions for a fast finishing and thus increased productivity.

Sublim is perfect for multiple prints with high ink levels, as well as for a variety of finishes (embossing, gilding, varnishing, lamination...).





































It offers excellent creasing and folding capabilities.

Among the many other application: business reports, art books, brochures and high-quality advertising.









Available from 80 gsm to 400 gsm.



SUBLIM BRIGHT

	Ref.	Sizes (mm)	Gsm	Pallet Sizes (mm)	Stacks	Sheets / Pallet	Tabbed by	Pallet Net Weight (kg)
	3972C	460 x 640	100g	940 x 670	2	15 000	500	442
	3973C	460 x 640	120g	940 x 670	2	13 000	250	459
	3974C	460 x 640	150g	940 x 670	2	10 500	250	464
	3975C	460 x 640	170g	940 x 670	2	9 000	250	450
	3976C	460 x 640	200g	940 x 670	2	7 500	125	442
	3977C	460 x 640	240g	940 x 670	2	6 500	125	459
	3194C	460 x 640	300g	940 x 670	2	6 000	125	530
	3986C	650 x 920	80g	960 x 690	1	11 000	250	526
	3987C	650 x 920	90g	960 x 690	1	10 000	250	538
	3988C	650 x 920	100g	960 x 690	1	7 500	250	449
	3989C	650 x 920	120g	960 x 690	1	6 500	250	466
	3990SC	650 x 920	150g	960 x 690	1	5 250	125	471
	3991C	650 x 920	170g	960 x 690	1	4 500	125	457
	3992C	650 x 920	200g	960 x 690	1	3 750	125	449
	3993C	650 x 920	240g	960 x 690	1	3 250	125	466
	3170C	650 x 920	300g	960 x 690	1	2 800	100	502
	3978C	920 x 650	80g	960 x 690	1	11 000	250	526
	3909C	920 x 650	100g	960 x 690	1	7 500	250	449
	3927C	920 x 650	120g	960 x 690	1	6 500	250	466
	3911SC	920 x 650	150g	960 x 690	1	5 250	125	471
	3913C	920 x 650	170g	960 x 690	1	4 500	125	457
	3928C	920 x 650	200g	960 x 690	1	3 750	125	449
	3173C	920 x 650	240g	960 x 690	1	3 250	125	466
	3824C	920 x 650	300g	960 x 690	1	2 800	100	502
	3189C	700 x 1000	80g	1040 x 720	1	9 500	250	532
	3174C	700 x 1000	90g	1040 x 720	1	8 500	250	536
	3175C	700 x 1000	100g	1040 x 720	1	7 500	250	525
	3176C	700 x 1000	120g	1040 x 720	1	6 500	250	546
	3179C	700 x 1000	150g	1040 x 720	1	5 250	125	551
	3180C	700 x 1000	170g	1040 x 720	1	4 500	125	536
	3181C	700 x 1000	200g	1040 x 720	1	3 750	125	525
	3182C	700 x 1000	240g	1040 x 720	1	3 250	125	546
	3171C	700 x 1000	300g	1040 x 720	1	2 800	100	588
	3196C	700 x 1000	400g	1040 x 720	1	2 000	50	560
	3901C	1000 x 700	80g	1040 x 720	1	9 500	250	532
	3917C	1000 x 700	90g	1040 x 720	1	8 500	250	536

SUBLIM BRIGHT

	Ref.	Sizes (mm)	Gsm	Pallet Sizes (mm)	Stacks	Sheets / Pallet	Tabbed by	Pallet Net Weight (kg)
	3918C	1000 x 700	100g	1040 x 720	1	7 500	250	525
	3183C	1000 x 700	120g	1040 x 720	1	6 500	250	546
	3920C	1000 x 700	150g	1040 x 720	1	5 250	125	551
	3184C	1000 x 700	170g	1040 x 720	1	4 500	125	536
	3926C	1000 x 700	200g	1040 x 720	1	3 750	125	525
	3185C	1000 x 700	240g	1040 x 720	1	3 250	125	546
	3172C	1000 x 700	300g	1040 x 720	1	2 800	100	588
	3197C	1000 x 700	400g	1040 x 720	1	2 000	50	560



FICHE TECHNIQUE / code 730-543 TECHNICAL DATA SHEET

	80	100	120	150	200	250	300
Thickness (µm)	97	121	140	175	230	288	340
Bulk (cm ³ /g)	1.21	1.21	1.17	1.17	1.15	1.15	1.13
Bendtsen Roughness (ml/min)	200	200	200	200	200	200	160
Absolute Humidity (%H ₂ O)	5.0	5.0	5.5	6.0	6.5	6.5	7.0
Relative Humidity (% in the air)	38	38	44	44	48	50	60
Opacity (%)	94	96	98	>99	>99	>99	>99

Afin de garantir l'épaisseur et la rugosité de ce papier, le grammage peut être ajusté en conséquence. Cette dernière valeur doit donc être considérée comme indicative.

In order to guarantee the thickness and the roughness of this paper, the grammage may be adjusted accordingly. This latter value should thus be considered as indicative.

GAMME RANGE

	80	100	120	150	200	250	300
 460 x 640 mm	3107C	3108C	3109C	3111C			
 700 x 1000 mm	3112C	3113C	3116C	3122C	3124C	3135C	3125C
 1000 x 700 mm	3126C	3128C	3130C	3131C	3132C	3136C	3133C



www.blauer-engel.de/uz14a



The mark of responsible forestry



135 CIE



ROUGHNESS

LIFE SUBLIM







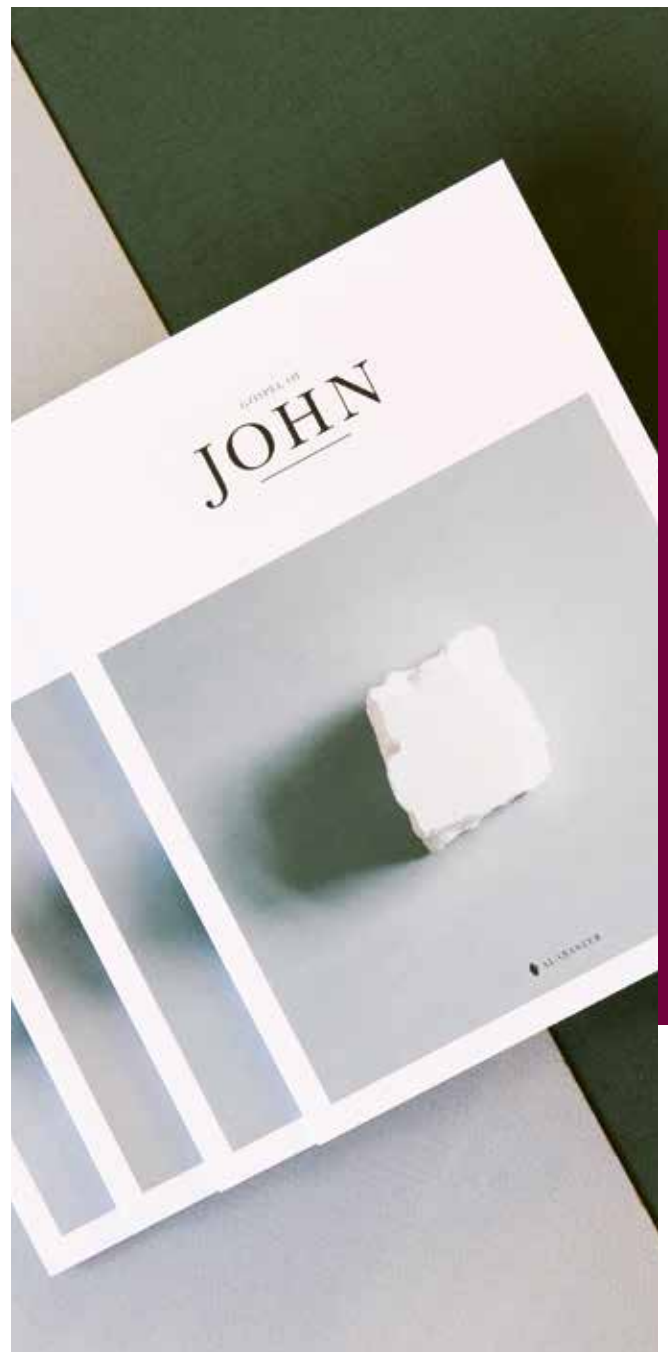











REBECCA Sublim

La technologie Clairtech au service d'un offset premium 100% recyclé.
Garantir à la fois des rendus d'impressions proches d'un papier couché et le toucher nature d'un papier de caractère sur un support issu de 100 % de fibres de récupération, tel est le pari relevé avec brio par Clairefontaine !
Life Sublim offre une infinité de perspectives nouvelles à l'industrie graphique grâce à ce support hors du commun.
Disponible de 80 g/m² à 300 g/m².

Clairtech technology at the service and forefront of offset printing Premium 100% recycled.
Clairefontaine has successfully met the challenge of guaranteeing printing results close to those of a coated paper and the natural feel of a character paper made from 100% recycled fibres!
Life Sublim offers an infinite number of new perspectives to the graphics industry thanks to this unusual material.
Available from 80 gsm to 300 gsm.



LIFE SUBLIM

	Ref.	Sizes (mm)	Gsm	Pallet Sizes (mm)	Stacks	Sheets / Pallet	Tabbed by	Pallet Net Weight (kg)
	3107C	460 x 640	80g	940 x 670	2	24 000	500	565
	3108C	460 x 640	100g	940 x 670	2	18 000	500	530
	3109C	460 x 640	120g	940 x 670	2	16 000	250	565
	3111C	460 x 640	150g	940 x 670	2	12 000	250	530
	3112C	700 x 1000	80g	1040 x 720	1	12 000	250	672
	3113C	700 x 1000	100g	1040 x 720	1	9 000	250	630
	3116C	700 x 1000	120g	1040 x 720	1	8 000	250	672
	3122C	700 x 1000	150g	1040 x 720	1	6 000	125	630
	3124C	700 x 1000	200g	1040 x 720	1	4 500	125	630
	3135C	700 x 1000	250g	1040 x 720	1	4 000	125	700
	3125C	700 x 1000	300g	1040 x 720	1	3 000	100	630
	3126C	1000 x 700	80g	1040 x 720	1	12 000	250	672
	3128C	1000 x 700	100g	1040 x 720	1	9 000	250	630
	3130C	1000 x 700	120g	1040 x 720	1	8 000	250	672
	3131C	1000 x 700	150g	1040 x 720	1	6 000	125	630
	3132C	1000 x 700	200g	1040 x 720	1	4 500	125	630
	3136C	1000 x 700	250g	1040 x 720	1	4 000	125	700
	3133C	1000 x 700	300g	1040 x 720	1	3 000	100	630

SPIRIT of PAPER®

1
05/2026

Parce qu'il est un acteur historique du marché.
Parce qu'il maîtrise de A à Z toutes les étapes de production, transformation et livraison.
Parce qu'il dispose d'une capacité d'invention technique pour répondre rapidement à toutes les demandes, Clairefontaine propose des gammes de papiers pour la chaîne graphique.

Clairefontaine, c'est d'abord une marque emblématique et son logo – la Verseuse Rebecca.

C'est aussi un siècle et demi d'une connaissance filiale et intime du papier qui a forgé des produits devenus des classiques. Qu'il s'agisse du cahier d'écolier au toucher iconique ou de la rame Clairalfa qui accompagne avec exigence notre environnement de bureau.

Clairefontaine c'est tout cela : un savoir-faire français, une histoire, une audace.

Mieux. Clairefontaine c'est une certaine idée, un certain esprit du papier.

Ce Spirit of Paper prend pour nom Rebecca. Qu'elles soient Rock, Sublim ou Life, les gammes Rebecca affirment toute l'autorité Clairefontaine dans la maîtrise des papiers offset haut de gamme.

Because we are a historic leading player in the market.

Because we master all the stages of production, converting and delivery from A to Z.

Because we have the technical invention capacity to meet quickly all requests, Clairefontaine offers several ranges of papers for the graphic chain.

Clairefontaine is first of all an emblematic brand with its logo Rebecca. Our intimate knowledge of paper of a century and a half has forged products which have become best sellers.

Whether it is the exercise book with its iconic touch or the Clairalfa ream which accompanies our office environment, Clairefontaine is all this : French know-how, a history and audaciousness!

Even more. Clairefontaine is a certain idea, a certain spirit of paper.

This Spirit of Paper has taken the name Rebecca. Whether they are named Rock, Sublim or Life, the Rebecca ranges assert all the Clairefontaine authority in the mastery of top-of-the-range offset papers.



Papeteries de Clairefontaine
F - 88480 Etival Clairefontaine
Tel. +33 (0)3 29 42 42 42

info@clairefontaine.eu - www.clairefontaine.eu

Follow us on LinkedIn 

SPIRIT of PAPER®

2

05/2026

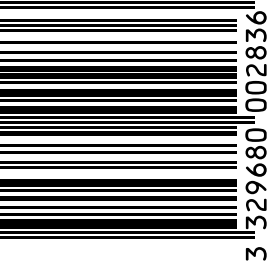

Mai 2026

#10123

Clairefontaine
GraphicalPaper



2

SOMMAIRE



02

L'ESPRIT REBECCA

06

Rebecca Life

OFFSET • LASER • INKJET	EVERBULK PREMIUM WHITE 1.5	12
OFFSET • LASER • INKJET	EVERPRINT PREMIUM WHITE	16
OFFSET • LASER • INKJET	EVERSATIN PREMIUM WHITE	22
OFFSET • LASER • INKJET	EVERPRINT WHITE	26
OFFSET • LASER	EVERPRINT WHITE LIGHT COATED	32

Rebecca Studio

HP INDIGO • OFFSET • LASER	SAUVAGE	38
OFFSET • LASER	TRADITION WHITE	42
OFFSET • LASER	HERITAGE WHITE	46
OFFSET • LASER	HERITAGE NATURAL WHITE	50
OFFSET • LASER	EMPIRE LAID EXTRA WHITE / IVORY	54
OFFSET • LASER	VALORISE WHITE	58
OFFSET • LASER	VALORISE NATURAL	62
OFFSET • LASER	VALORISE IVORY	66
HP INDIGO • OFFSET • LASER	ECO KRAFT BOULEAU / ECRU / MUSCAT	70
HP INDIGO • OFFSET • LASER	DECKLES EDGES	74

À RETROUVER DANS LE TOME 1 :



Rebecca Envelopes

CROSS BRIGHT
EVERPRINT PREMIUM WHITE
ROUGH ORIGINAL
ROUGH NATURAL
EMPIRE LAID EXTRA WHITE
EMPIRE LAID IVORY
DECKLES EDGES

Rebecca Cross

CROSS BRIGHT

Rebecca Rock

BRUT BRIGHT
ROUGH BRIGHT
INDIGO BRIGHT
SILK BRIGHT
BRUT ORIGINAL
ROUGH ORIGINAL
INDIGO ORIGINAL
SILK ORIGINAL
BRUT NATURAL WHITE
ROUGH NATURAL WHITE
BRUT NATURAL
ROUGH NATURAL
SILK NATURAL

Rebecca Bulk

CLAIRBOOK 1.5 EXTRA WHITE
CLAIRBOOK 1.5 / 1.8 / 2.0 NATURAL WHITE
CLAIRBOOK 1.5 / 1.8 / 2.0 IVORY

Rebecca Sublim

SUBLIM BRIGHT
LIFE SUBLIM

1

SOMMAIRE

Imprimé sur : couverture DCP 250g/m² - pages intérieures DCP 80g/m²



Rebecca Thin

OFFSET • LASER • INKJET	C-OPAK	82
OFFSET • LASER • INKJET	SMART-PRINT	82

Rebecca High Speed Inkjet

LASER • INKJET	ICY ORIGINAL	88
LASER • INKJET	CLAIRJET 400 BRIGHT	92
LASER • INKJET	CLAIRJET 400 SMOOTH	96
LASER • INKJET	EVERJET PREMIUM	100

Rebecca Color

HP INDIGO • OFFSET • LASER	GENYOU [®] WHITE	106
HP INDIGO • OFFSET • LASER	GENYOU [®] BLACK INTENSE	110
OFFSET • LASER	TROPHÉE / PAPAGO	114
OFFSET • LASER	TROPHÉE NEON	120
OFFSET • LASER	BENGALI	124

Fabrications en formats possibles jusqu'à 800 g/m² pour l'ensemble de la gamme des papiers.

*A exception de Rebecca Thin et Rebecca High Speed Inkjet.

Manufacturing in sheets available up to 800 gsm for the entire range of papers.

* Except for Rebecca Thin and Rebecca High Speed Inkjet.

Découvrez nos produits certifiés FSC[®] dans ce catalogue.



CONTACTS

Do not hesitate to contact your dedicated key account manager:

France:

Emmanuelle HUBERT: +33 6 80 51 75 84 • emmanuelle.hubert@clairefontaine.eu
Jean-Marc DUBOIS: +33 6 21 98 22 46 • jean-marc.dubois@clairefontaine.eu

Germany / Switzerland / Austria / Eastern Europe / Scandinavia:

Ansgar REINERS: +49 1 736 985 267 • ansgar.reiners@clairefontaine.eu
Axel FREVERT: +49 1 742 126 788 • axel.frevert@clairefontaine.eu
Rainer KOPISCHKE: +49 1 704 873 286 • rainer.kopischke@clairefontaine.eu

Benelux:

Laurent HEESTERBEEK: +32 460 971 432 • laurent.heesterbeek@clairefontaine.eu

Central Europe / Baltic:

Andréas FRANZOLINI: +33 750 060 213 • andreas.franzolini@clairefontaine.eu

Italia:

Simone MEDICI: +39 3 387 279 185 • simone.medici@clairefontaine.eu

United Kingdom:

Dean GLEW: +44 7 355 629 346 • dean.glew@clairefontaine.eu

Envelopes Department:

Laetitia SCHIRR: +33 3 29 27 20 97 • contact-envelopes@clairefontaine.eu

Qu'est-ce qu'un beau papier ?

Qu'est-ce qu'une belle impression ?

À ces deux questions, Clairefontaine répond avec la même compétence. Un « beau papier », cela signifie une esthétique, une main, un rapport à la matière qui crée un lien, incarne la substance d'un projet. Une « belle impression », c'est un papier efficace qui pour l'imprimeur donnera contraste, brillance, uniformité, supportera Pantone, fer à dorer, vernis. Toute la notoriété des papiers Clairefontaine s'exprime dans ces supports non couchés, haut de gamme et tous certifiés FSC®. La parfaite maîtrise de leur production garantit une impression sans écueils. Profondeur et couleurs ne souffrent d'aucune altération.

Clairefontaine destine ses gammes graphiques aux imprimeurs, aux designers, aux éditeurs, aux agences de communication, aux "créateurs fous et culottés", au monde vaste de l'impression, de la création et de l'édition, à celles et ceux qui recherchent un support haut de gamme pour affirmer une idée, un concept.

Pour tous ces professionnels, Clairefontaine propose des papiers graphiques à la hauteur de leur ambition au sein de neuf gammes : Rebecca Cross - Rebecca Rock - Rebecca Bulk - Rebecca Sublim - Rebecca Life - Rebecca Studio - Rebecca Thin - Rebecca High Speed Inkjet - Rebecca Color.

What is a beautiful paper?

What is a beautiful print?

Clairefontaine answers these two questions with the same competence. A «beautiful paper» means an aesthetic relationship with bulk that creates a bond, which embodies the material of a project. A «beautiful print» is an effective paper that for the printer, will give contrast, brilliance and uniformity, will support all Pantones, gold dust and varnish.

All the authority of Clairefontaine papers is expressed in these uncoated, top-of-the-range FSC® and ECF certified uncoated papers. The Operational Excellence of the manufacturing process avoids the printing pitfalls. Depth and colours do not suffer any alteration.

Clairefontaine's graphic ranges are aimed at printers, designers, publishers, communication agencies, audacious and creative strategists, the vast world of printing, creation and publishing, and those looking for a top-of-the-range medium to assert an idea or a concept.

For them Clairefontaine offers graphic papers which match their ambition in nine ranges: Rebecca Cross - Rebecca Rock - Rebecca Bulk - Rebecca Sublim - Rebecca Life - Rebecca Studio - Rebecca Thin - Rebecca High Speed Inkjet - Rebecca Color.

YOUR PERFECT DESIGN PARTNER

YOUR PERFECT DESIGN PARTNER



L'ESPRIT REBECCA

REBECCA SPIRIT



Trois mots définissent nos gammes :

expertise, esthétique, efficacité.

Nos papiers graphiques reçoivent tout notre savoir-faire, toute notre expertise en matière de traitement de surface. Nous avons pour ambition qu'ils répondent sans failles à un degré d'exigence élevé afin de former un support parfait. Enfin, ils se doivent d'être d'une machinabilité optimale pour les imprimeurs.

Ces gammes incarnent notre idée d'un papier graphique, son esprit.

En hommage au logo de notre marque, nous les avons baptisés Rebecca, du nom de cette figure féminine et bienveillante du livre de la Genèse qui accompagne l'histoire de Clairefontaine.

Three words define our ranges:

expertise, excellence, efficiency.

Our graphic papers have received all our know-how, all our expertise in surface treatment. Our ambition is that they meet a high level of requirements without fail in order to form a perfect medium. Finally, they must be of optimum runnability for printers.

These ranges exemplify our idea of a graphic paper, its spirit.

As a tribute to our brand logo, we have named the range Rebecca, after the feminine and benevolent figure from the Book of Genesis that accompanies the history of Clairefontaine.

Rebecca Life

LE GREENPAPER DE DEMAIN

Les utilisateurs qui font le choix de la gamme Rebecca Life choisissent un papier issu de 100% de fibres de récupération. Ils ne transigent pas avec la volonté d'un geste éco-responsable, d'une inscription dans une économie circulaire. Clairefontaine répond à cet engagement sans céder à la qualité qui fait la réputation de la marque. La gamme Rebecca Life dispose ainsi des mêmes propriétés d'impression que ses papiers fabriqués avec des fibres vierges.

THE GREENPAPER OF TOMORROW

Users who choose the Rebecca Life range choose a paper made from 100% recovered fibres. They do not compromise with the desire for an eco-responsible mindset but an inscription in a circular economy. Clairefontaine responds to this commitment without compromising the quality that has made the brand's reputation. The Rebecca Life range thus has the same printing properties as its papers made from virgin fibres.

Rebecca Studio

UNE DIMENSION TACTILE POUR VOS CRÉATIONS

Rebecca Studio fait la part belle aux papiers d'édition, plaçant la créativité au cœur de chaque projet et véhiculant le concept d'un espace où les idées prennent vie et où l'expression artistique est encouragée et célébrée. Chaque texture, chaque finition, offre profondeur et sobriété au projet, ainsi, le papier devient la toile où se joue la magie de la lumière et de la composition, transformant un simple texte ou image en œuvre d'art.

A TOUCH FOR YOUR CREATIONS

Rebecca Studio is all about paper, placing creativity at the heart of every project and conveying the concept of a space where ideas come to life and where artistic expression is encouraged and celebrated. Each texture, each finish, offers depth and sobriety to the project so that the paper becomes the canvas where the magic of light and composition is played out, transforming a simple text or image into a work of art.



Rebecca Thin L'ÉLOGE DE LA LÉGÈRETÉ

Réduire le poids des documents, trouver un support mince permettant un ouvrage à forte pagination, utiliser un papier pour les pliales multiples d'une notice, Rebecca Thin vous permet tout cela.
Gamme de 40 à 70g/m² adaptée à l'impression offset, laser ou jet d'encre.

THE PRAISE OF LIGHTNESS

Reducing the weight of documents, finding a thin support for a high-pagination book, finding a paper for multiple folds of a leaflet, Rebecca Thin allows you to do all of this.
Range from 40 to 70 gsm suitable for offset, laser or inkjet printing.

Rebecca High Speed Inkjet

La gamme High Speed Inkjet a été spécifiquement développée pour cette technologie d'impression et est à même de couvrir le large spectre des demandes clients. Que ce soient pour des documents texte, des papiers fins pour notice, des papiers bouffants d'édition ou des supports destinés à une forte couverture d'encre, vous trouverez forcément la réponse à tous vos besoins d'impression.

THE PRAISE OF LIGHTNESS

The High-Speed Inkjet range consists of papers specifically developed for this printing technology and capable of covering the broad spectrum of customer requirements. Whether it's for text documents, thin papers for leaflets, bulky publishing papers or media designed for high ink coverage, you're bound to find the answer to all your printing needs.

Rebecca Color LIBÉREZ VOTRE IMAGINATION

Créez une émotion en combinant des couleurs, en jouant des contrastes. Rebecca Color ce sont de nombreuses teintes et grammages à disposition pour donner libre cours à votre imagination. Pastels très douces, intensives flamboyantes, noir ou fluorescentes, vous trouverez parmi toutes ces références les clés d'une communication personnalisée. Utilisable en offset ou impression numérique. Existe en fibres vierges ou recyclées.

FREE YOUR IMAGINATION

Create emotion by combining colours and playing with contrasts. Rebecca Color offers a wide range of shades and weights, giving free rein to your imagination.
From ultra-soft pastels and bold, vibrant tones to deep blacks and striking fluorescents, you will find the perfect options to bring your personalised communication to life.
Suitable for offset or digital printing. Available in virgin or recycled fibres.



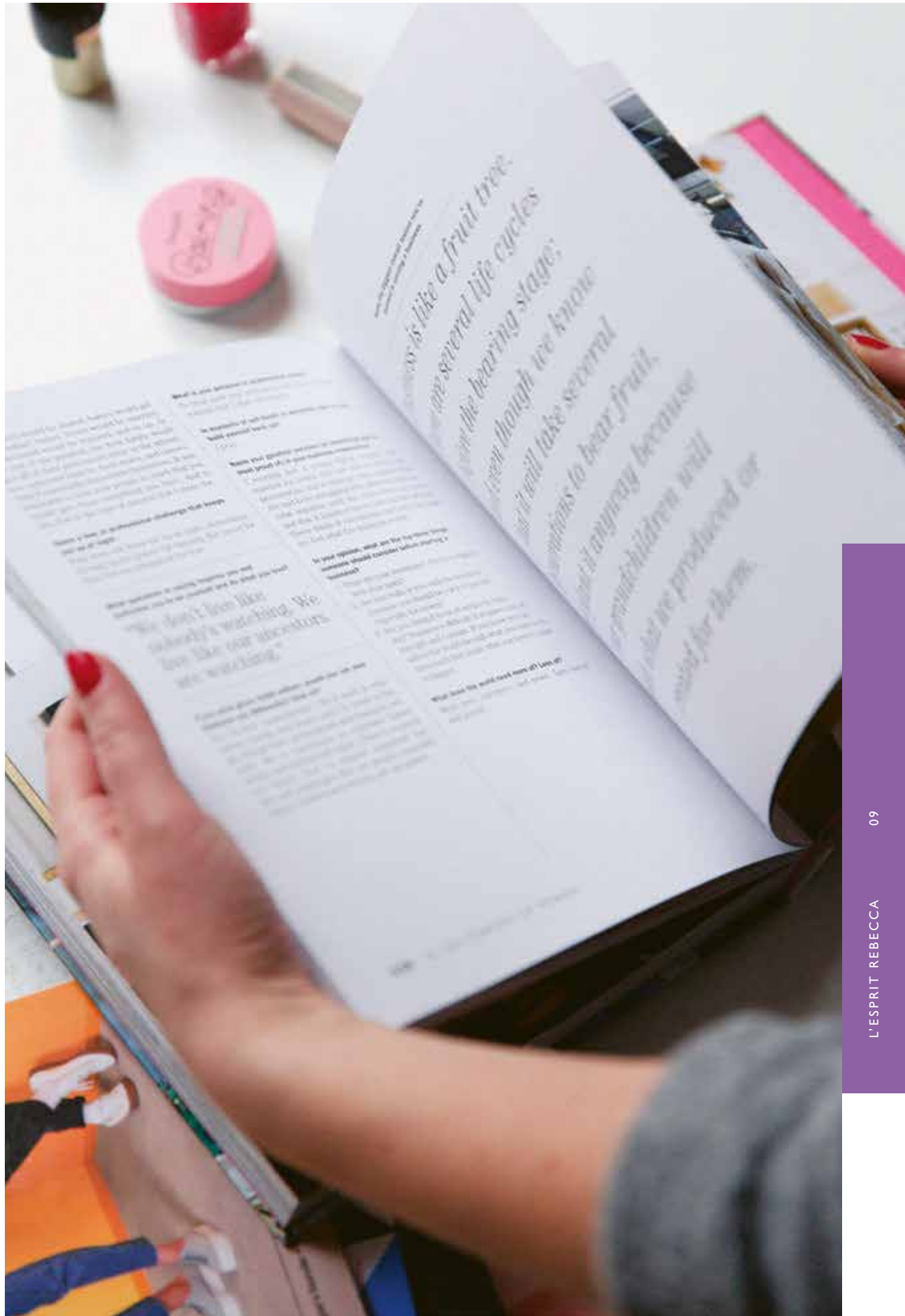

EVERBULK PREMIUM WHITE 1.5
EVERPRINT PREMIUM WHITE
EVERSATIN PREMIUM WHITE
EVERPRINT WHITE
EVERPRINT WHITE LIGHT COATED



Listen to the silence

On the foot of Mount Ogura,
you will encounter the silence of Niou-in Temple.
True silence is not soundless.
Through the maple and cherry blossom lined approach,
awaits the forgotten sounds of silence.
The rustling of trees, chirping birds and flowing water.
Immerse yourself in the tranquil flow of time at Niou-in
and adore the timeless sounds of nature.



FICHE TECHNIQUE / code 650 TECHNICAL DATA SHEET

	90	100	120	150	170	200	240	300	350
Thickness (µm)	135	150	180	225	255	300	360	450	525
Bulk (cm ³ /g)	1.5	1.5	1.5	1.5	1.5	1.5	1.5	1.5	1.5
Bendtsen Roughness (ml/min)	800	800	800	800	800	800	800	800	800
Absolute Humidity (%H ₂ O)	5.0	5.0	5.5	5.5	5.5	6.0	6.5	6.5	6.5
Relative Humidity (% in the air)	40	40	45	45	45	50	56	56	56
Opacity (%)	96	97	98	99	>99	>99	>99	>99	>99

GAMME RANGE

	90	100	120	150	170	200	240	300	350
720 x 1020 mm	20720C	20721C	20722C	20723C	20724C	20725C	20726C	20727C	20728C
720 x 1020 mm	20720PC	20721PC	20722PC	20723PC	20724PC	20725PC	20726PC	20727PC	20728PC

Absolute Humidity (%H ₂ O)	5.0	5.0	5.0	5.0	5.5	5.5	6.0	6.5	6.5	6.5	6.5	6.5
Relative Humidity (% in the air)	38	38	38	38	44	44	48	50	50	50	50	50



www.blauer-engel.de/uz14a



EU Ecolabel
www.ecolabel.eu
EU Ecolabel - FR/011/005
Please collect used paper for recycling



FSC
www.fsc.org
FSC® C062221
The mark of responsible forestry



135 CIE



ROUGHNESS

EVERBULK PREMIUM WHITE 1.5



















REBECCA Life

L'intensité d'un papier, la légèreté d'une empreinte.
Issu à 100 % de fibres de récupération, ce papier brut séduit par sa main exceptionnelle de 1,5, gage de présence et de tenue. Non couché, il conserve toute la sincérité de la matière recyclée, pour des rendus puissants et une expression graphique affirmée. Sa blancheur naturelle, sa grande opacité et sa stabilité dimensionnelle en font un support fiable pour les applications offset et preprint exigeantes.
Éthique, Esthétique, Everbulk !

The intensity of a paper, the lightness of a print.
Made from 100% recycled fibres, this raw paper has an exceptional bulk weight of 1.5, a guarantee of presence and strength. Uncoated, it retains all the sincerity of the recycled material, for powerful renderings and assertive graphic expression. Its natural whiteness, high opacity and dimensional stability make it a reliable paper for demanding offset and preprint applications. Ethical, Aesthetic, Everbulk!



EVERBULK PREMIUM WHITE 1.5

Ref.	Sizes (mm)	Gsm	Pallet Sizes (mm)	Stacks	Sheets / Pallet	Tabbed by	Pallet Net Weight (kg)
 20720C	720 x 1020	90g	750 x 1050	1	9 000	250	595
 20721C	720 x 1020	100g	750 x 1050	1	8 000	250	588
 20722C	720 x 1020	120g	750 x 1050	1	7 000	125	617
 20723C	720 x 1020	150g	750 x 1050	1	5 000	125	551
 20724C	720 x 1020	170g	750 x 1050	1	4 000	125	499
 20725C	720 x 1020	200g	750 x 1050	1	3 750	125	551
 20726C	720 x 1020	240g	750 x 1050	1	3 000	125	529
 20727C	720 x 1020	300g	750 x 1050	1	2 500	100	551
 20728C	720 x 1020	350g	750 x 1050	1	2 200	50	565
 20720PC	720 x 1020	90g	750 x 1050	1	9 000	250	595
 20721PC	720 x 1020	100g	750 x 1050	1	8 000	250	588
 20722PC	720 x 1020	120g	750 x 1050	1	7 000	125	617
 20723PC	720 x 1020	150g	750 x 1050	1	5 000	125	551
 20724PC	720 x 1020	170g	750 x 1050	1	4 000	125	499
 20725PC	720 x 1020	200g	750 x 1050	1	3 750	125	551
 20726PC	720 x 1020	240g	750 x 1050	1	3 000	125	529
 20727PC	720 x 1020	300g	750 x 1050	1	2 500	100	551
 20728PC	720 x 1020	350g	750 x 1050	1	2 200	50	565

EVERPRINT PREMIUM WHITE



FICHE TECHNIQUE / code 770 TECHNICAL DATA SHEET

	70	80	90	100	120	140	160	200	250	300	350	400
Thickness (µm)	89	102	113	125	150	172	197	246	307	354	413	472
Bulk (cm³/g)	1.27	1.28	1.25	1.25	1.25	1.23	1.23	1.23	1.23	1.18	1.18	1.18
Bendtsen Roughness (ml/min)	250	250	250	250	250	250	250	250	250	250	250	250
Absolute Humidity (%H ₂ O)	5.0	5.0	5.0	5.0	5.5	5.5	5.5	6.0	6.5	6.5	6.5	6.5
Relative Humidity (% in the air)	40	40	40	40	45	45	45	50	56	56	56	56
Opacity (%)	93	95	96	97	>99	>99	>99	>99	>99	>99	>99	>99

Afin de garantir l'épaisseur et la rugosité de ce papier, le grammage peut être ajusté en conséquence. Cette dernière valeur doit donc être considérée comme indicative.
 In order to guarantee the thickness and the roughness of this paper, the grammage may be adjusted accordingly. This latter value should thus be considered as indicative.

GAMME RANGE

	70	80	90	100	120	140	160	200	250	300	350	400
450 x 640 mm		1544C	1545C		1547C							
460 x 640 mm				1615C								
630 x 880 mm		Z0223C	Z0224C		Z0226C		Z0228C			Z0231C		
630 x 880 mm		Z0280C	Z0281C	Z0282C	Z0283C	Z0284C	Z0285C	Z0286C	Z0287C	Z0288C		
880 x 630 mm		1556C	Z0232C	1582C	Z0322C	Z0233C	1585C	Z0234C	Z0235C	Z0236C		
880 x 630 mm		Z0289C	Z0290C	Z0291C	Z0292C	Z0293C	Z0294C	Z0295C	Z0296C	Z0297C		
650 x 920 mm		G0211C	G0214C	G0215C	G0217C	G0220C	G0223C	G0226C	G0229C			
920 x 650 mm		G0210C	G0213C	G0216C	G0218C	G0221C	G0224C	G0227C	G0230C			
700 x 1000 mm	1554C	1557C	1569C	1570C	1566C	Z0237C	1558C	1626C	1559C	Z0640C	Z0321C	
700 x 1000 mm		Z0298C	Z0299C	Z0300C	Z0301C	Z0302C	Z0303C	Z0304C	Z0305C	Z0306C	Z0319C	
1000 x 700 mm		1560C	1572C	1573C	1565C	Z0240C	1561C	1627C	1562C	Z0241C	Z0320C	
1000 x 700 mm		Z0307C	Z0308C	Z0309C	Z0310C	Z0311C	Z0312C	Z0313C	Z0314C	Z0315C	Z0318C	
720 x 1020 mm										1564C		1590C
1020 x 720 mm										1563C		1591C

STOCKED ENVELOPES

CF. Page 20



www.blauer-engel.de/uz14a



EU Ecolabel: FR/011/006
 Please collect used paper for recycling



The mark of responsible forestry



135 CIE



ROUGHNESS

EVERPRINT PREMIUM WHITE

REBECCA Life

Le papier graphique recyclé par excellence !

Everprint Premium White fait partie de la gamme des papiers recyclés. Spécialement conçu pour les applications offset et preprint, ce papier est fabriqué à partir de 100 % de fibres de récupération sans compromis sur la qualité. En effet, les matières premières entrant dans sa composition sont rigoureusement sélectionnées afin de garantir un très haut niveau de blancheur, une stabilité dimensionnelle irréprochable et des rendus d'impression saisissants !

Son procédé de fabrication a été pensé pour limiter autant que possible son impact sur l'environnement par l'absence de blanchiment au chlore et une génération de déchets très limitée au cours du procédé.

Everprint Premium White, c'est le choix de la fiabilité avec la signature recyclée en plus !

Disponible de 70 à 400 g/m².

The choicest recycled paper!

Everprint Premium White is made from 100 % recycled fibres without compromising on quality. Raw materials are selected to offer the best whiteness, dimensional stability and outstanding printing quality in offset or preprint.

Its production process greatly limits environmental impact by using biomass energy, by avoiding chlorinated fibre bleaching and by generating little waste.

With Everprint Premium White you choose reliability with a recycled signature.

Available from 70 to 400 gsm.























EVERPRINT PREMIUM WHITE

	Ref.	Sizes (mm)	Gsm	Pallet Sizes (mm)	Stacks	Sheets / Pallet	Tabbed by	Pallet Net Weight (kg)
	1614C	450 x 320	160g	940 x 670	2	20 000	250	461
	1544C	450 x 640	80g	940 x 670	2	20 000	500	461
	1545C	450 x 640	90g	940 x 670	2	18 000	500	467
	1547C	450 x 640	120g	940 x 670	2	13 000	250	449
	1615C	460 x 640	100g	940 x 670	2	15 000	500	442
	Z0223C	630 x 880	80g	920 x 660	1	9 000	250	399
	Z0280C	630 x 880	80g	920 x 660	1	9 000	250	399
	Z0224C	630 x 880	90g	920 x 660	1	8 000	250	399
	Z0281C	630 x 880	90g	920 x 660	1	8 000	250	399
	Z0282C	630 x 880	100g	920 x 660	1	7 500	250	416
	Z0226C	630 x 880	120g	920 x 660	1	5 500	125	366
	Z0283C	630 x 880	120g	920 x 660	1	5 500	125	366
	Z0284C	630 x 880	140g	920 x 660	1	5 500	125	427
	Z0228C	630 x 880	160g	920 x 660	1	5 000	125	444
	Z0285C	630 x 880	160g	920 x 660	1	5 000	125	444
	Z0286C	630 x 880	200g	920 x 660	1	4 500	125	499
	Z0287C	630 x 880	250g	920 x 660	1	3 250	125	450
	Z0231C	630 x 880	300g	920 x 660	1	2 500	100	416
	Z0288C	630 x 880	300g	920 x 660	1	2 500	100	416
	G0211C	650 x 920	80g	960 x 690	1	9 000	250	431
	G0214C	650 x 920	90g	960 x 690	1	8 000	250	431
	G0215C	650 x 920	100g	960 x 690	1	7 500	250	449
	G0217C	650 x 920	120g	960 x 690	1	7 000	125	502
	G0220C	650 x 920	140g	960 x 690	1	5 500	125	460
	G0223C	650 x 920	160g	960 x 690	1	5 000	125	478
	G0226C	650 x 920	200g	960 x 690	1	4 500	125	538
	G0229C	650 x 920	250g	960 x 690	1	3 250	125	486
	G0210C	920 x 650	80g	960 x 690	1	9 000	250	431
	G0213C	920 x 650	90g	960 x 690	1	8 000	250	431
	G0216C	920 x 650	100g	960 x 690	1	7 500	250	449
	G0218C	920 x 650	120g	960 x 690	1	7 000	125	502
	G0221C	920 x 650	140g	960 x 690	1	5 500	125	460
	G0224C	920 x 650	160g	960 x 690	1	5 000	125	478
	G0227C	920 x 650	200g	960 x 690	1	4 500	125	538
	G0230C	920 x 650	250g	960 x 690	1	3 250	125	486
	1556C	880 x 630	80g	920 x 660	1	9 000	250	399
	Z0289C	880 x 630	80g	920 x 660	1	9 000	250	399
	Z0232C	880 x 630	90g	920 x 660	1	8 000	250	399

EVERPRINT PREMIUM WHITE

	Ref.	Sizes (mm)	Gsm	Pallet Sizes (mm)	Stacks	Sheets / Pallet	Tabbed by	Pallet Net Weight (kg)
	Z0290C	880 × 630	90g	920 × 660	1	8 000	250	399
	1582C	880 × 630	100g	920 × 660	1	7 500	250	416
	Z0291C	880 × 630	100g	920 × 660	1	7 500	250	416
	Z0322C	880 × 630	120g	920 × 660	1	5 500	125	366
	Z0292C	880 × 630	120g	920 × 660	1	5 500	125	366
	Z0233C	880 × 630	140g	920 × 660	1	5 500	125	427
	Z0293C	880 × 630	140g	920 × 660	1	5 500	125	427
	1585C	880 × 630	160g	920 × 660	1	5 000	125	444
	Z0294C	880 × 630	160g	920 × 660	1	5 000	125	444
	Z0234C	880 × 630	200g	920 × 660	1	4 500	125	499
	Z0295C	880 × 630	200g	920 × 660	1	4 500	125	499
	Z0235C	880 × 630	250g	920 × 660	1	3 250	125	450
	Z0296C	880 × 630	250g	920 × 660	1	3 250	125	450
	Z0236C	880 × 630	300g	920 × 660	1	2 500	100	416
	Z0297C	880 × 630	300g	920 × 660	1	2 500	100	416
	1554C	700 × 1000	70g	1040 × 700	1	12 000	250	588
	1557C	700 × 1000	80g	1040 × 720	1	9 000	250	504
	Z0298C	700 × 1000	80g	1040 × 720	1	9 000	250	504
	1569C	700 × 1000	90g	1040 × 720	1	8 000	250	504
	Z0299C	700 × 1000	90g	1040 × 720	1	8 000	250	504
	1570C	700 × 1000	100g	1040 × 720	1	7 500	250	525
	Z0300C	700 × 1000	100g	1040 × 720	1	7 500	250	525
	1566C	700 × 1000	120g	1040 × 720	1	5 500	125	462
	Z0301C	700 × 1000	120g	1040 × 720	1	5 500	125	462
	Z0237C	700 × 1000	140g	1040 × 720	1	5 500	125	539
	Z0302C	700 × 1000	140g	1040 × 720	1	5 500	125	539
	1558C	700 × 1000	160g	1040 × 720	1	5 000	125	560
	Z0303C	700 × 1000	160g	1040 × 720	1	5 000	125	560
	1626C	700 × 1000	200g	1040 × 720	1	4 500	125	630
	Z0304C	700 × 1000	200g	1040 × 720	1	4 500	125	630
	1559C	700 × 1000	250g	1040 × 720	1	3 250	125	569
	Z0305C	700 × 1000	250g	1040 × 720	1	3 250	125	569
	Z0306C	700 × 1000	300g	1040 × 720	1	2 500	100	525
	Z0640SC	700 × 1000	300g	1040 × 720	1	2 500	100	525
	Z0321C	700 × 1000	350g	1040 × 720	1	2 250	75	551
	Z0319C	700 × 1000	350g	1040 × 720	1	2 250	75	551
	1560C	1000 × 700	80g	1040 × 720	1	9 000	250	504
	Z0307C	1000 × 700	80g	1040 × 720	1	9 000	250	504
	1572C	1000 × 700	90g	1040 × 720	1	8 000	250	504
	Z0308C	1000 × 700	90g	1040 × 720	1	8 000	250	504

EVERPRINT PREMIUM WHITE

Ref.	Sizes (mm)	Gsm	Pallet Sizes (mm)	Stacks	Sheets / Pallet	Tabbed by	Pallet Net Weight (kg)
 1573C	1000 x 700	100g	1040 x 720	1	7 500	250	525
 Z0309C	1000 x 700	100g	1040 x 720	1	7 500	250	525
 1565C	1000 x 700	120g	1040 x 720	1	5 500	125	462
 Z0310C	1000 x 700	120g	1040 x 720	1	5 500	125	462
 Z0240C	1000 x 700	140g	1040 x 720	1	5 500	125	539
 Z0311C	1000 x 700	140g	1040 x 720	1	5 500	125	539
 1561C	1000 x 700	160g	1040 x 720	1	5 000	125	560
 Z0312C	1000 x 700	160g	1040 x 720	1	5 000	125	560
 1627C	1000 x 700	200g	1040 x 720	1	4 500	125	630
 Z0313C	1000 x 700	200g	1040 x 720	1	4 500	125	630
 1562C	1000 x 700	250g	1040 x 720	1	3 250	125	569
 Z0314C	1000 x 700	250g	1040 x 720	1	3 250	125	569
 Z0315C	1000 x 700	300g	1040 x 720	1	2 500	100	525
 Z0241C	1000 x 700	300g	1040 x 720	1	2 500	100	525
 Z0318C	1000 x 700	350g	1040 x 720	1	2 250	75	551
 Z0320C	1000 x 700	350g	1040 x 720	1	2 250	75	551
 1564C	720 x 1020	300g	1050 x 750	1	2 500	100	551
 1590C	720 x 1020	400g	1050 x 750	1	2 000	50	588
 1563C	1020 x 720	300g	1050 x 750	1	2 500	100	551
 1591C	1020 x 720	400g	1050 x 750	1	2 000	50	588



STOCKED ENVELOPES

80 gsm

ADHESIVE RECYCLED ENVELOPES

Ref.	Sizes (mm)	Gsm	Flap	Window	Units / Box	Box / Weight (kg)	Pallet Sizes (mm)	Units / Pallet	Pallet Net Weight (kg)
1450C	DL - 110 x 220	80	adhesive	∅	500	2,35	120 x 80	104	244
1451C	DL - 110 x 220	80	adhesive	35x100 (20/20)	500	2,40	120 x 80	104	250
1452C	DL - 110 x 220	80	adhesive	45x100 (20/20)	500	2,40	120 x 80	104	250
1453C	C5 - 162 x 229	80	adhesive	∅	500	3,48	120 x 80	66	210
1454C	C5 - 162 x 229	80	adhesive	45x100 (62/20)	500	3,48	120 x 80	66	210

DL - 110x220mm

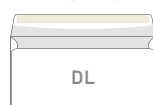

Window : 35x100

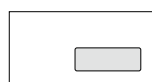

Window : 45x100

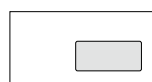

C5 - 162x229mm

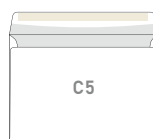

Window : 45x100

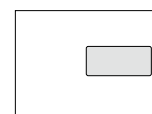

EVERSATIN PREMIUM WHITE





FICHE TECHNIQUE / code 649 TECHNICAL DATA SHEET

	90	100	120	150	170	200	240	300	350
Thickness (µm)	96	107	128	160	182	220	264	330	385
Bulk (cm³/g)	1.07	1.07	1.07	1.07	1.07	1.1	1.1	1.1	1.1
Bekk smoothness (s)	70	70	70	70	70	70	70	70	70
Absolute Humidity (%H ₂ O)	5.0	5.0	5.5	5.5	5.5	6.0	6.5	6.5	6.5
Relative Humidity (% in the air)	40	40	45	45	45	50	56	56	56
Opacity (%)	96	97	98	99	>99	>99	>99	>99	>99

Afin de garantir l'épaisseur et la rugosité de ce papier, le grammage peut être ajusté en conséquence. Cette dernière valeur doit donc être considérée comme indicative.
 In order to guarantee the thickness and the roughness of this paper, the grammage may be adjusted accordingly. This latter value should thus be considered as indicative.

GAMME RANGE

	90	100	120	150	170	200	240	300	350
 720 x 1020 mm	20760C	20761C	20762C	20763C	20764C	20765C	20766C	20767C	20768C
 720 x 1020 mm	20760PC	20761PC	20762PC	20763PC	20764PC	20765PC	20766PC	20767PC	20768PC



www.blauer-engel.de/uz14a



The mark of responsible forestry



135 CIE



ROUGHNESS

EVERSATIN PREMIUM WHITE

REBECCA Life

Eversatin Premium White est un papier recyclé haut de gamme, spécialement conçu pour l'impression offset et la pré-impression. Entièrement fabriqué à partir de fibres 100% recyclées, il allie respect de l'environnement et qualité d'impression exceptionnelle.

Sa surface présente un fini satiné prononcé, offrant un toucher lisse et un aspect visuel élégant. Les couleurs apparaissent plus riches, les zones pleines plus uniformes, et le texte est d'une netteté et d'une lisibilité exceptionnelles.

Son processus de fabrication est résolument respectueux de l'environnement, minimisant l'impact environnemental grâce à l'absence de blanchiment au chlore et à une très faible production de déchets.

Eversatin Premium White est un papier recyclé performant, esthétique et responsable, offrant un fini satiné distinctif pour des supports de communication à forte valeur ajoutée.







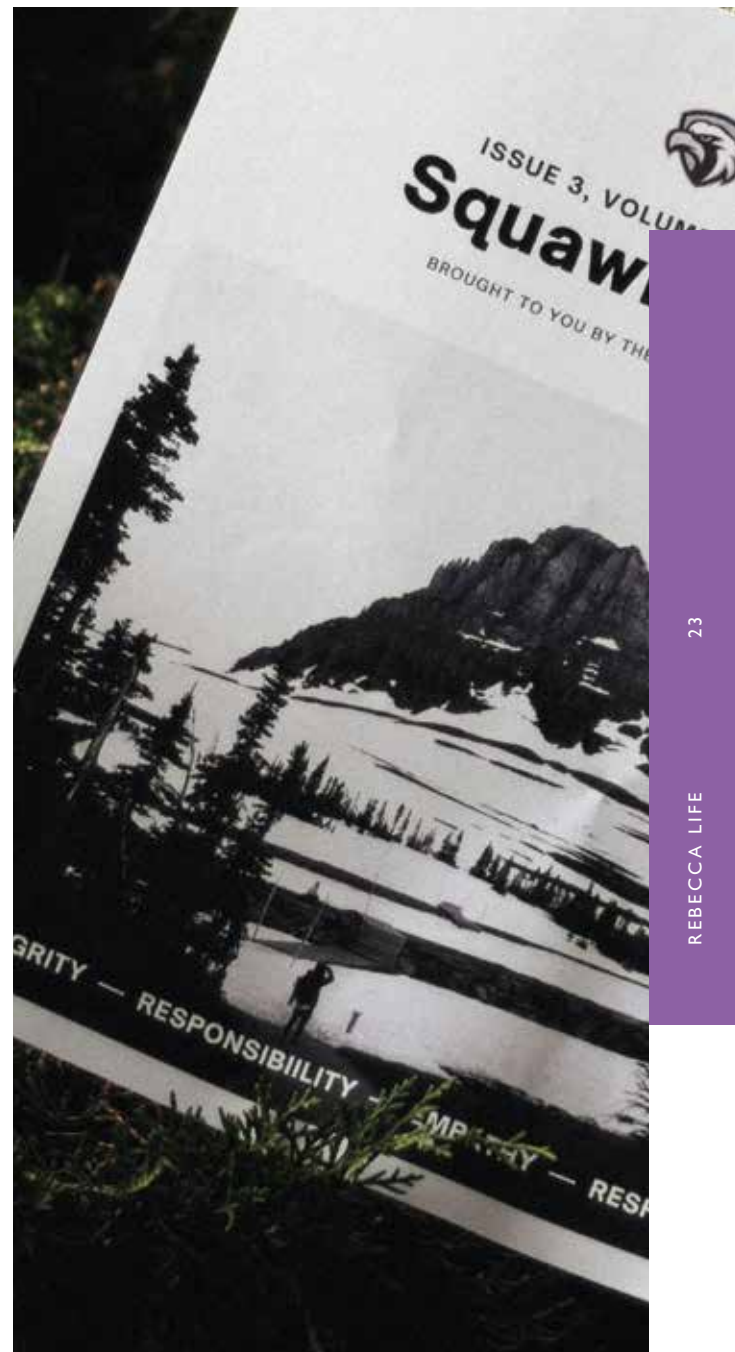











Eversatin Premium White is a premium recycled paper, specially crafted for offset and preprint applications. Made entirely from 100% recovered fibres, it combines environmental responsibility with exceptional print quality. Its surface features a pronounced satin finish, providing a smooth tactile feel and an elegant visual appearance. Colours appear richer, solid areas more uniform, and text is exceptionally crisp and readable.

Its manufacturing process is firmly eco-friendly, minimising environmental impact through the absence of chlorine bleaching and very low waste production.

Eversatin Premium White is a choice of a high-performance, aesthetically pleasing, and responsible recycled paper, offering a distinctive satin finish for communication materials with strong added value.



EVERSATIN PREMIUM WHITE

	Ref.	Sizes (mm)	Gsm	Pallet Sizes (mm)	Stacks	Sheets / Pallet	Tabbed by	Pallet Net Weight (kg)
	20760C	1000 × 700	90G	1050 × 750	1	11 000	250	727
	20761C	1000 × 700	100g	1050 × 750	1	10 000	250	734
	20762C	1000 × 700	120g	1050 × 750	1	8 500	125	749
	20763C	1000 × 700	150g	1050 × 750	1	6 500	125	716
	20764C	1000 × 700	170g	1050 × 750	1	6 000	125	749
	20765C	1000 × 700	200g	1050 × 750	1	5 000	125	734
	20766C	1000 × 700	240g	1050 × 750	1	4 250	125	749
	20767C	1000 × 700	300g	1050 × 750	1	3 400	100	749
	20768C	1000 × 700	350g	1050 × 750	1	2 800	50	720
	20760PC	1000 × 700	90g	1050 × 750	1	11 000	250	727
	20761PC	1000 × 700	100g	1050 × 750	1	10 000	250	734
	20762PC	1000 × 700	120g	1050 × 750	1	8 500	125	749
	20763PC	1000 × 700	150g	1050 × 750	1	6 500	125	716
	20764PC	1000 × 700	170g	1050 × 750	1	6 000	125	749
	20765PC	1000 × 700	200g	1050 × 750	1	5 000	125	734
	20766PC	1000 × 700	240g	1050 × 750	1	4 250	125	749
	20767PC	720 × 1020	300g	1050 × 750	1	3 400	100	749
	20768PC	720 × 1020	350g	1050 × 750	1	2 800	50	720

EVERPRINT WHITE



FICHE TECHNIQUE / code 769 TECHNICAL DATA SHEET

	70	80	90	100	110	135	150	170	250	300	350
Thickness (µm)	90	102	113	125	137	166	184	209	307	348	406
Bulk (cm³/g)	1.28	1.28	1.25	1.25	1.25	1.23	1.23	1.23	1.23	1.16	1.16
Bendtsen Roughness (ml/min)	250	250	250	250	250	250	250	250	250	250	250
Absolute Humidity (%H ₂ O)	5.0	5.0	5.0	5.0	5.0	5.5	6.0	6.0	6.5	6.5	6.5
Relative Humidity (% in the air)	38	38	38	38	38	44	48	48	50	50	50
Opacity (%)	94	96	97	97	98	>99	>99	>99	>99	>99	>99

Afin de garantir l'épaisseur et la rugosité de ce papier, le grammage peut être ajusté en conséquence. Cette dernière valeur doit donc être considérée comme indicative.
 In order to guarantee the thickness and the roughness of this paper, the grammage may be adjusted accordingly. This latter value should thus be considered as indicative.

GAMME RANGE

	70	80	90	100	110	135	150	170	250	300	350
430 x 610 mm	Z0185C										
430 x 610 mm	Z0242C										
440 x 630 mm	Z0186C										
440 x 630 mm	Z0243C										
450 x 640 mm	L0007C	L0015C	L0023C	L0030C							
610 x 860 mm	Z0187C										
630 x 880 mm	Z0188C	Z0189C	Z0190C	Z0191C	Z0192C	Z0193C	Z0194C	Z0195C			
630 x 880 mm	Z0245C	Z0246C	Z0247C	Z0248C	Z0249C	Z0250C	Z0251C	Z0252C			
640 x 880 mm	L0002C	L0010C	L0018C	L0025C	L0033C	L0037C	L0043C	L0048C			
880 x 630 mm	Z0196C	Z0197C	Z0198C	Z0199C	Z0200C	Z0201C	Z0202C	Z0203C			
880 x 630 mm	Z0253C	Z0254C	Z0255C	Z0256C	Z0257C	Z0258C	Z0259C	Z0260C			
650 x 920 mm	L0004C	L0012C	L0020C	L0027C	G0240C	L0039C	L0045C	G0243C	G0245C	L0057C	
920 x 650 mm	G0232C	G0234C	G0236C	G0238C	Z0204C	Z0205C					
920 x 650 mm	Z0261C					Z0262C					
700 x 1000 mm	Z0206C	Z0207C	Z0208C	Z0209C	Z0210C	L0041C	Z0211C	Z0212C	Z0213C		
700 x 1000 mm	Z0263C	Z0264C	Z0265C	Z0266C	Z0267C	Z0268C	Z0269C	Z0270C			
1000 x 700 mm	Z0214C	Z0215C	Z0216C	Z0217C	Z0218C	Z0219C	Z0220C				
1000 x 700 mm	Z0271C	Z0272C	Z0317C	Z0273C	Z0274C	Z0275C	Z0276C	Z0277C			
720 x 1020 mm									L0054C	Z0221C	L0060C
720 x 1020 mm											Z0278C
1020 x 720 mm											Z0222C
1020 x 720 mm											Z0279C



www.blauer-engel.de/uz14a



EU Ecolabel
 www.ecolabel.eu
 EU Ecolabel: FR/011/004
 Please collect used paper for recycling



FSC
 www.fsc.org
 FSC® C002321
 The mark of responsible forestry



95 CIE



ROUGHNESS

EVERPRINT WHITE



































REBECCA Life

Le papier recyclé qui s'affiche.
Everprint White partage avec Everprint Premium White les mêmes qualités d'imprimabilité et le même procédé de fabrication à impact environnemental très réduit.
Sa blancheur moins élevée montre clairement son origine.
Everprint White est le choix d'un papier visiblement recyclé à partir de 100% de fibres récupération.
Disponible de 70 g/m² à 350 g/m².





































The recycled paper that displays itself.
Everprint White shares with Everprint Premium White the same printability and the same manufacturing process with a very low environmental impact. Its lower whiteness clearly shows its origin.
Everprint White is the choice of a visibly recycled paper from 100% recycled fibres.
Available from 70 gsm to 350 gsm.



EVERPRINT WHITE

	Ref.	Sizes (mm)	Gsm	Pallet Sizes (mm)	Stacks	Sheets / Pallet	Tabbed by	Pallet Net Weight (kg)
	Z0185C	430 × 610	80g	940 × 670	2	20 000	500	420
	Z0242C	430 × 610	80g	920 × 660	2	20 000	500	420
	Z0186C	440 × 630	80g	940 × 670	2	20 000	500	444
	Z0243C	440 × 630	80g	940 × 670	2	20 000	500	444
	L0007C	450 × 640	80g	940 × 670	2	20 000	500	461
	L0015C	450 × 640	90g	940 × 670	2	18 000	500	467
	L0023C	450 × 640	100g	940 × 670	2	15 000	500	432
	L0030C	450 × 640	110g	940 × 670	2	13 000	250	412
	Z0187C	610 × 860	80g	900 × 640	2	9 000	250	378
	Z0188C	630 × 880	70g	920 × 660	1	12 000	250	466
	Z0245C	630 × 880	70g	920 × 660	1	12 000	250	466
	Z0189C	630 × 880	80g	920 × 660	1	9 000	250	399
	Z0246C	630 × 880	80g	920 × 660	1	9 000	250	399
	Z0190C	630 × 880	90g	920 × 660	1	8 000	250	399
	Z0247C	630 × 880	90g	920 × 660	1	8 000	250	399
	Z0191C	630 × 880	100g	920 × 660	1	7 500	250	416
	Z0248C	630 × 880	100g	920 × 660	1	7 500	250	416
	Z0192C	630 × 880	110g	920 × 660	1	8 000	250	488
	Z0249C	630 × 880	110g	920 × 660	1	8 000	250	488
	Z0193C	630 × 880	150g	920 × 660	1	6 000	125	499
	Z0250C	630 × 880	150g	920 × 660	1	6 000	125	499
	Z0194C	630 × 880	170g	920 × 660	1	5 500	125	518
	Z0251C	630 × 880	170g	920 × 660	1	5 500	125	518
	Z0195C	630 × 880	250g	920 × 660	1	3 250	125	450
	Z0252C	630 × 880	250g	920 × 660	1	3 250	125	450
	L0002C	640 × 880	70g	940 × 670	1	12 000	250	473
	L0010C	640 × 880	80g	940 × 670	1	9 000	250	406
	L0018C	640 × 880	90g	940 × 670	1	8 000	250	406
	L0025C	640 × 880	100g	940 × 670	1	7 500	250	422
	L0033C	640 × 880	110g	940 × 670	1	8 000	250	496
	L0037C	640 × 880	135g	940 × 670	1	5 500	125	418
	L0043C	640 × 880	150g	940 × 670	1	6 000	125	507
	L0048C	640 × 880	170g	940 × 670	1	5 500	125	527
	Z0196C	880 × 630	70g	920 × 660	1	12 000	250	466
	Z0253C	880 × 630	70g	920 × 660	1	12 000	250	466

EVERPRINT WHITE

	Ref.	Sizes (mm)	Gsm	Pallet Sizes (mm)	Stacks	Sheets / Pallet	Tabbed by	Pallet Net Weight (kg)
	Z0197C	880 x 630	80g	920 x 660	1	9 000	250	399
	Z0254C	880 x 630	80g	920 x 660	1	9 000	250	399
	Z0198C	880 x 630	90g	920 x 660	1	8 000	250	399
	Z0255C	880 x 630	90g	920 x 660	1	8 000	250	399
	Z0199C	880 x 630	100g	920 x 660	1	7 500	250	416
	Z0256C	880 x 630	100g	920 x 660	1	7 500	250	416
	Z0200C	880 x 630	110g	920 x 660	1	8 000	250	488
	Z0257C	880 x 630	110g	920 x 660	1	8 000	250	488
	Z0201C	880 x 630	150g	920 x 660	1	6 000	125	499
	Z0258C	880 x 630	150g	920 x 660	1	6 000	125	499
	Z0202C	880 x 630	170g	920 x 660	1	5 500	125	518
	Z0259C	880 x 630	170g	920 x 660	1	5 500	125	518
	Z0203C	880 x 630	250g	920 x 660	1	3 250	125	450
	Z0260C	880 x 630	250g	920 x 660	1	3 250	125	450
	L0004C	650 x 920	70g	960 x 690	1	12 000	250	502
	L0012C	650 x 920	80g	960 x 690	1	9 000	250	431
	L0020C	650 x 920	90g	960 x 690	1	8 000	250	431
	L0027C	650 x 920	100g	960 x 690	1	7 500	250	449
	G0240C	650 x 920	110g	960 x 690	1	8 000	250	526
	L0039C	650 x 920	135g	960 x 690	1	5 500	125	444
	L0045C	650 x 920	150g	960 x 690	1	6 000	125	538
	G0243C	650 x 920	170g	960 x 690	1	5 500	125	559
	G0245C	650 x 920	250g	960 x 690	1	3 250	125	486
	L0057C	650 x 920	300g	960 x 690	1	2 500	100	449
	G0232C	920 x 650	70g	960 x 690	1	12 000	250	502
	G0234C	920 x 650	80g	960 x 690	1	9 000	250	431
	G0236C	920 x 650	90g	960 x 690	1	8 000	250	431
	G0238C	920 x 650	100g	960 x 690	1	7 500	250	449
	Z0204C	920 x 650	110g	960 x 690	1	8 000	250	526
	Z0261C	920 x 650	110g	960 x 690	1	8 000	250	526
	Z0205C	920 x 650	150g	960 x 690	1	6 000	125	538
	Z0262C	920 x 650	150g	960 x 690	1	6 000	125	538
	Z0206C	700 x 1000	70g	1040 x 720	1	12 000	250	588
	Z0263C	700 x 1000	70g	1040 x 720	1	12 000	250	588
	Z0207C	700 x 1000	80g	1040 x 720	1	9 000	250	504
	Z0264C	700 x 1000	80g	1040 x 720	1	9 000	250	504
	Z0208C	700 x 1000	90g	1040 x 720	1	8 000	250	504

EVERPRINT WHITE

	Ref.	Sizes (mm)	Gsm	Pallet Sizes (mm)	Stacks	Sheets / Pallet	Tabbed by	Pallet Net Weight (kg)
	Z0265C	700 × 1000	90g	1040 × 720	1	8 000	250	504
	Z0209C	700 × 1000	100g	1040 × 720	1	7 500	250	525
	Z0266C	700 × 1000	100g	1040 × 720	1	7 500	250	525
	Z0210C	700 × 1000	110g	1040 × 720	1	8 000	250	616
	Z0267C	700 × 1000	110g	1040 × 720	1	8 000	250	616
	L0041C	700 × 1000	135g	1040 × 720	1	5 500	125	520
	Z0211C	700 × 1000	150g	1040 × 720	1	5 500	125	578
	Z0268C	700 × 1000	150g	1040 × 720	1	5 500	125	578
	Z0212C	700 × 1000	170g	1040 × 720	1	5 500	125	655
	Z0269C	700 × 1000	170g	1040 × 720	1	5 500	125	655
	Z0213C	700 × 1000	250g	1040 × 720	1	3 250	125	569
	Z0270C	700 × 1000	250g	1040 × 720	1	3 250	125	569
	Z0214C	1000 × 700	70g	1040 × 720	1	12 000	250	588
	Z0271C	1000 × 700	70g	1040 × 720	1	12 000	250	588
	Z0215C	1000 × 700	80g	1040 × 720	1	9 000	250	504
	Z0272C	1000 × 700	80g	1040 × 720	1	9 000	250	504
	Z0317C	1000 × 700	90g	1040 × 720	1	8 000	250	504
	Z0216C	1000 × 700	100g	1040 × 720	1	7 500	250	525
	Z0273C	1000 × 700	100g	1040 × 720	1	7 500	250	525
	Z0217C	1000 × 700	110g	1040 × 720	1	8 000	250	616
	Z0274C	1000 × 700	110g	1040 × 720	1	8 000	250	616
	Z0218C	1000 × 700	150g	1040 × 720	1	5 500	125	578
	Z0275C	1000 × 700	150g	1040 × 720	1	5 500	125	578
	Z0219C	1000 × 700	170g	1040 × 720	1	5 500	125	655
	Z0276C	1000 × 700	170g	1040 × 720	1	5 500	125	655
	Z0220C	1000 × 700	250g	1040 × 720	1	3 250	125	569
	Z0277C	1000 × 700	250g	1040 × 720	1	3 250	125	569
	L0054C	720 × 1020	250g	1050 × 750	1	3 250	125	597
	Z0221C	720 × 1020	300g	1050 × 750	1	2 500	100	551
	Z0278C	720 × 1020	300g	1050 × 750	1	2 500	100	551
	L0060C	720 × 1020	350g	1050 × 750	1	2 250	75	578
	Z0222C	1020 × 720	300g	1050 × 750	1	2 500	100	551
	Z0279C	1020 × 720	300g	1050 × 750	1	2 500	100	551

EVERPRINT WHITE LIGHT COATED







FICHE TECHNIQUE / code 768 TECHNICAL DATA SHEET

	80	90	100	115	135	150	170	200	250	300
Thickness (µm)	80	90	100	115	135	150	170	190	238	294
Bulk (cm ³ /g)	1.00	1.00	1.00	1.00	1.00	1.00	1.00	0.95	0.95	0.98
Bekk smoothness (s)	150	150	150	150	150	150	150	150	150	150
Absolute Humidity (%H ₂ O)	5.5	5.5	5.5	5.5	5.5	5.5	5.5	5.5	5.5	6.5
Relative Humidity (% in the air)	44	44	44	44	44	44	44	44	44	50

Afin de garantir l'épaisseur et la rugosité de ce papier, le grammage peut être ajusté en conséquence. Cette dernière valeur doit donc être considérée comme indicative.

In order to guarantee the thickness and the roughness of this paper, the grammage may be adjusted accordingly. This latter value should thus be considered as indicative.

GAMME RANGE

	80	90	100	115	135	150	170	200	250	300
 450 x 640 mm	50501C	50502C	50503C	50504C	50505C	50548C				
 630 x 880 mm	50506C	50507C	50508C	50546C	50547C					
 880 x 630 mm	50509C	50510C	50511C							
 650 x 920 mm	50512C	50513C	50514C	50515C	50516SC	50517C	50518C			
 920 x 650 mm	50519C	50520C	50521C	50522C	50523C	50524C	50525C			
 720 x 1020 mm	50526C	50527C	50528C	50529SC	50530SC	50531C	50532C	50540C	50541C	50542C
 1020 x 720 mm	50533C	50534C	50535C	50536C	50537C	50538C	50539C	50543C	50544C	50545C



www.blauer-engel.de/uz14a



EU Ecolabel: FR/011/001
Please collect used paper for recycling



The mark of responsible forestry



95 CIE

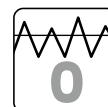

ROUGHNESS

EVERPRINT WHITE LIGHT COATED

REBECCA Life

Pour des impressions éco-responsables de haute qualité. Everprint White Light Coated est un papier fabriqué avec des fibres de cellulose 100 % recyclées.

Son état de surface, à la fois couché et satiné, garantit des résultats d'impression exceptionnels en offset. Sa blancheur naturelle, permet un champ élargi de restitution des couleurs et des nuances.

Son satinage léger, lui confère un toucher très soyeux et assure un grand confort de lecture.

Certifié FSC® recyclé et fabriqué en France, Everprint White Light Coated est disponible du 80 g/m² au 300 g/m² pour s'adapter à toutes les applications : plaquettes commerciales ou institutionnelles, rapports annuels, journaux, revues, catalogues, beaux livres, calendriers...

For high quality eco-responsible prints.

Everprint White Light Coated is a paper made with 100 % recycled, cellulose fibres.





































Its surface finish, both coated and satin-finish, guarantees exceptional offset printing results. Its natural whiteness, 95 CIE, allows a wider range of colours and shades to be reproduced. Its light satin finish gives it a very silky touch and ensures great visual comfort.

Certified FSC® recycled and manufactured in France, Everprint Light Coated is the signature of high quality eco-responsible prints.











Everprint White Light Coated is available from 80 gsm to 300 gsm to suit all applications: commercial or institutional brochures, annual reports, newspapers, magazines, catalogues, beautiful books, calendars...



EVERPRINT WHITE LIGHT COATED

	Ref.	Sizes (mm)	Gsm	Pallet Sizes (mm)	Stacks	Sheets / Pallet	Tabbed by	Pallet Net Weight (kg)
	50501C	450 x 640	80g	940 x 670	2	28 000	500	645
	50502C	450 x 640	90g	940 x 670	2	25 000	500	648
	50503C	450 x 640	100g	940 x 670	2	22 000	500	634
	50504C	450 x 640	115g	940 x 670	2	20 000	250	662
	50505C	450 x 640	135g	940 x 670	2	17 000	250	661
	50548C	450 x 640	150g	940 x 670	2	15 000	250	648
	50506C	630 x 880	80g	920 x 660	1	14 000	250	621
	50507C	630 x 880	90g	920 x 660	1	12 000	250	599
	50508C	630 x 880	100g	920 x 660	1	11 000	250	610
	50546C	630 x 880	115g	920 x 660	1	10 000	250	638
	50547C	630 x 880	135g	920 x 660	1	8 500	250	636
	50509C	880 x 630	80g	920 x 660	1	14 000	250	621
	50510C	880 x 630	90g	920 x 660	1	12 000	250	599
	50511C	880 x 630	100g	920 x 660	1	11 000	250	610
	50512C	650 x 920	80g	960 x 690	1	14 000	250	670
	50513C	650 x 920	90g	960 x 690	1	12 500	250	673
	50514C	650 x 920	100g	960 x 690	1	11 000	250	658
	50515C	650 x 920	115g	960 x 690	1	10 000	250	688
	50516SC	650 x 920	135g	960 x 690	1	8 500	250	686
	50517C	650 x 920	150g	960 x 690	1	7 500	125	673
	50518C	650 x 920	170g	960 x 690	1	6 500	125	661
	50519C	920 x 650	80g	960 x 690	1	14000	250	670
	50520C	920 x 650	90g	960 x 690	1	12 500	250	673
	50521C	920 x 650	100g	960 x 690	1	11 000	250	658
	50522C	920 x 650	115g	960 x 690	1	10 000	250	688
	50523C	920 x 650	135g	960 x 690	1	8 500	250	686
	50524C	920 x 650	150g	960 x 690	1	7 500	125	673
	50525C	920 x 650	170g	960 x 690	1	6 500	125	661
	50526C	720 x 1020	80g	1050 x 750	1	12 500	250	734
	50527C	720 x 1020	90g	1050 x 750	1	11 000	250	727
	50528C	720 x 1020	100g	1050 x 750	1	10 000	250	734
	50529SC	720 x 1020	115g	1050 x 750	1	8 500	250	718
	50530SC	720 x 1020	135g	1050 x 750	1	7 500	250	744
	50531C	720 x 1020	150g	1050 x 750	1	6 500	125	716
	50532C	720 x 1020	170g	1050 x 750	1	6 000	125	749
	50540C	720 x 1020	200g	1050 x 750	1	5 000	125	734
	50541C	720 x 1020	250g	1050 x 750	1	4 000	100	734

EVERPRINT WHITE LIGHT COATED

	Ref.	Sizes (mm)	Gsm	Pallet Sizes (mm)	Stacks	Sheets / Pallet	Tabbed by	Pallet Net Weight (kg)
	50542C	720 x 1020	300g	1050 x 750	1	3 500	100	771
	50533C	1020 x 720	80g	1050 x 750	1	12 500	250	734
	50534C	1020 x 720	90g	1050 x 750	1	11 000	250	727
	50535C	1020 x 720	100g	1050 x 750	1	10 000	250	734
	50536C	1020 x 720	115g	1050 x 750	1	8 500	250	718
	50537C	1020 x 720	135g	1050 x 750	1	7 500	250	744
	50538C	1020 x 720	150g	1050 x 750	1	6 500	125	716
	50539C	1020 x 720	170g	1050 x 750	1	6 000	125	749
	50543C	1020 x 720	200g	1050 x 750	1	5 000	125	734
	50544C	1020 x 720	250g	1050 x 750	1	4 000	100	734
	50545C	1020 x 720	300g	1050 x 750	1	3 500	100	771

SAUVAGE
TRADITION WHITE
HERITAGE WHITE
HERITAGE NATURAL WHITE
EMPIRE LAID EXTRA WHITE / IVORY
VALORISE WHITE
VALORISE NATURAL
VALORISE IVORY
ECO KRAFT BOULEAU / ECRU / MUSCAT
DECKLES EDGES



REBECCA Studio



FICHE TECHNIQUE / code 305

TECHNICAL DATA SHEET



	120	330
Thickness (µm)	170	470
Bulk (cm ³ /g)	1.42	1.42
Bendtsen Roughness (ml/min)	1200	2300
Absolute Humidity (%H ₂ O)	7.0	7.5
Relative Humidity (% in the air)	51	51
Opacity (%)	>90	>99

GAMME RANGE

	120	330
 1020 x 720 mm	0500120C0002G	0500330C0002G

Ces gammes sont disponibles à la rame, à l'unité.
These ranges are available per ream, per unit.

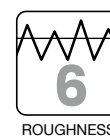

SAUVAGE

REBECCA Studio



Sauvage c'est une présence, une identité qui affirme d'emblée son caractère. Il attire le regard, impose une sensation, imprime un choix résolu. Sa texture singulière, à la fois naturelle et raffinée, séduit dès le premier contact. Sous les doigts, une douceur brute, authentique, presque instinctive. C'est le support idéal pour celles et ceux qui cherchent à marquer les esprits par le fond et la forme. Disponible en 120 g/m² ou 330 g/m², il révèle toute sa force dans les projets d'exception : éditions d'art, livres de luxe, cartes de vœux, invitations, catalogues, menus ou calendriers.

Sauvage is a presence, an identity that immediately states its character. It attracts the eye, imposes a sensation and makes a decisive choice. Its unique texture, both natural and refined, is seductive from the first touch. Under your fingers, you'll feel a raw, authentic, almost instinctive softness. It's the ideal paper for those who want to make a lasting impression through substance and form.

Available in 120 gsm or 330 gsm, it reveals all its strength in exceptional projects: art editions, luxury books, greetings cards, invitations, catalogues, menus or calendars.



SAUVAGE

Ref.	Sizes (mm)	Gsm	Pallet Sizes (mm)	Stacks	Sheets / Pallet	Tabbed by	Pallet Net Weight (kg)
 0500120C0002G	1020 x 720	120g	760 x 1080	1	6 000	-	529
 0500330C0002G	1020 x 720	330g	760 x 1080	1	2 400	-	582

TRADITION WHITE

FICHE TECHNIQUE / code 448 TECHNICAL DATA SHEET

	135	160	270	350	710
Thickness (µm)	195	230	390	500	1020
Bulk (cm ³ /g)	1.4	1.4	1.4	1.4	1.4
Bendtsen Roughness (ml/min)	800	800	800	800	>1200
Absolute Humidity (%H ₂ O)	6.5	6.5	6.5	6.5	7.0
Relative Humidity (% in the air)	50	50	50	50	50
Opacity (%)	85	85	>99	98	>99

GAMME RANGE

	135	160	270	350	710
 1000 x 700 mm	5706C	5707C	5708C	5704C	5705C
 720 x 1020 mm*	5700C	5701C	5702C		

* Jusqu'à épuisement des stocks.

* Will be definitively stopped when the stocks are depleted.

Ces gammes sont disponibles à la rame, à l'unité.

These ranges are available per ream, per unit.



TRADITION WHITE

REBECCA Studio

L'élégance intemporelle du coton, entre luxe et raffinement. Tradition White est un papier fabriqué à partir de fibres naturelles de coton et de cellulose qui lui confèrent une main importante et une opacité élevée. Parfait pour les impressions de haute qualité, il garantit une excellente netteté des couleurs et une transformation impeccable. Tradition White offre une texture luxueuse, présente une durabilité exceptionnelle et est particulièrement bien adapté au gaufrage et marquage à chaud. Son toucher doux et sa blancheur naturelle en font le support idéal pour les livres, magazines et autres publications de prestige.

Tradition White, pour une histoire qui s'écrit tout en douceur.







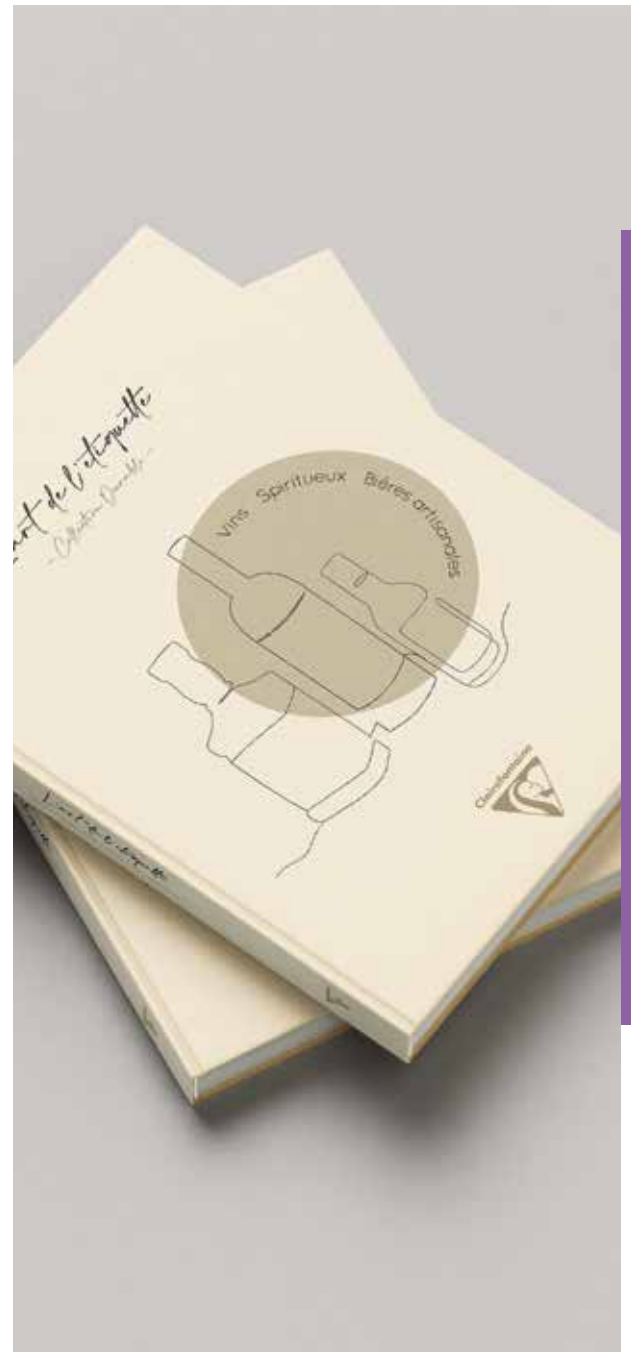

The timeless elegance of cotton, a blend of luxury and refinement.

Tradition White is a paper made from natural cotton and cellulose fibres, ensuring a high bulk and good opacity. Perfect for top-quality prints, it guarantees excellent colour sharpness and an impeccable processing. Tradition White offers a luxurious texture, exceptional durability and is particularly well suited to embossing and hot stamping. Its soft feel and natural whiteness make it ideal for books, magazines, and other prestigious publications.

Tradition White, for a story that unfolds with a gentle touch.



TRADITION WHITE

	Ref.	Sizes (mm)	Gsm	Pallet Sizes (mm)	Stacks	Sheets / Pallet	Tabbed by	Pallet Net Weight (kg)
	5706C	1000 × 700	135	1040 × 720	1	5 000	125	473
	5707C	1000 × 700	160	1040 × 720	1	4 250	125	476
	5708C	1000 × 700	270	1040 × 720	1	2 500	100	473
	5704C	1000 × 700	350	1040 × 720	1	2 100	75	515
	5705C	1000 × 700	710	1040 × 720	1	1 050	30	522
	5700C	720 × 1020	135g	1050 × 750	1	5 000	125	496
	5701C	720 × 1020	160g	1050 × 750	1	4 500	125	588
	5702C	720 × 1020	270g	1050 × 750	1	2 500	100	496

HERITAGE WHITE

FICHE TECHNIQUE / code 449 TECHNICAL DATA SHEET

	120	260	320
Thickness (µm)	170	360	450
Bulk (cm ³ /g)	1.4	1.4	1.4
Bendtsen Roughness (ml/min)	1300	3000	3000
Absolute Humidity (%H ₂ O)	6.5	6.5	6.5
Relative Humidity (% in the air)	50	50	50
Opacity (%)	>93	>99	>99



GAMME RANGE

	120	260	320
 1000 x 700 mm	5710C	5711C	5712SC

Ces gammes sont disponibles à la rame, à l'unité.
These ranges are available per ream, per unit.



140 CIE

HERITAGE WHITE



REBECCA Studio

Pour envelopper vos publications avec style. Papier marqué feutre, recto-verso, à la texture très douce et distinctive, Heritage White, offre une sensation de luxe au toucher et une finition texturée. Compatible avec les presses Offset, il se conforme aussi au gaufrage et à la dorure à chaud. Sa blancheur de 140 CIE, promesse d'une impression contrastée, est idéale pour les livres, magazines et brochures.

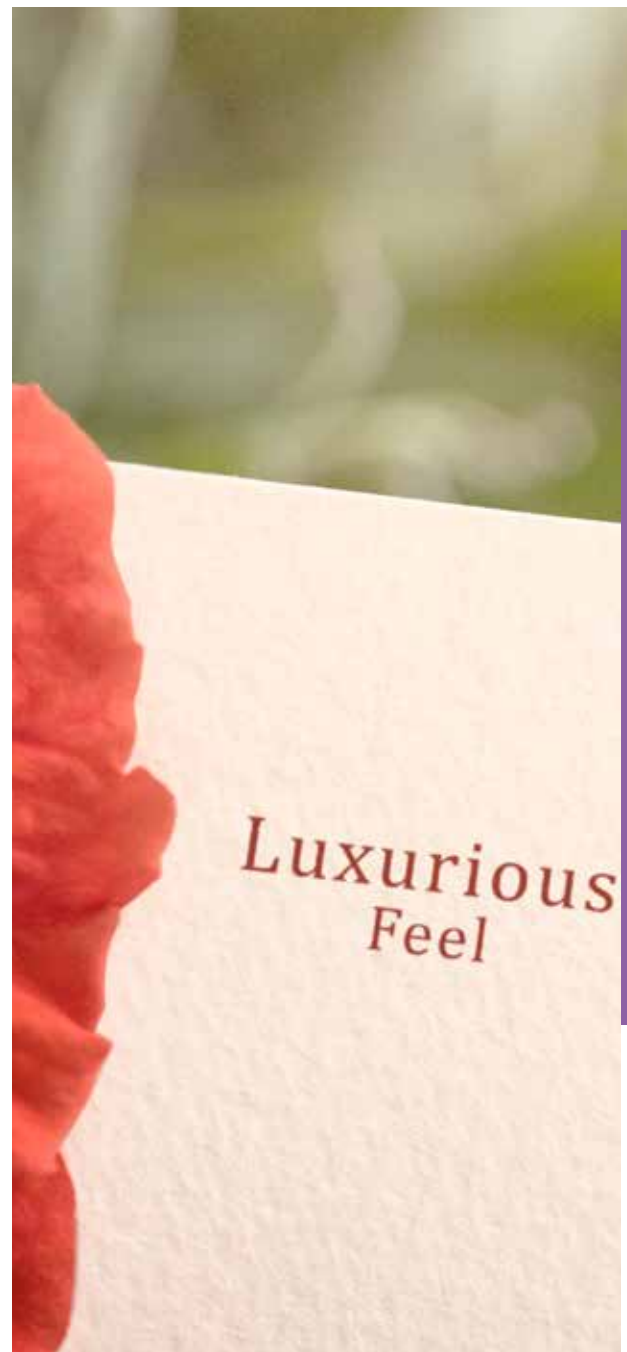
Envelop your publications in style. Heritage White is a double-sided felt-marked paper with a very soft and distinctive texture, offering a luxurious feel and a distinctive textured finish. Compatible with offset presses, it is also suitable for embossing and hot foil stamping. Its 140 CIE whiteness, a promise of high-contrast printing, is ideal for books, magazines, and brochures.



HERITAGE WHITE

	Ref.	Sizes (mm)	Gsm	Pallet Sizes (mm)	Stacks	Sheets / Pallet	Tabbed by	Pallet Net Weight (kg)
	5710C	1000 × 700	120g	1040 × 720	1	5 750	125	483
	5711C	1000 × 700	260g	1040 × 720	1	2 700	100	491
	5712SC	1000 × 700	320g	1040 × 720	1	2 150	50	482

FICHE TECHNIQUE / code 445 TECHNICAL DATA SHEET

	120	260	320
Thickness (µm)	170	360	450
Bulk (cm ³ /g)	1.4	1.4	1.4
Bendtsen Roughness (ml/min)	1300	3000	3000
Absolute Humidity (%H ₂ O)	6.5	6.5	6.5
Relative Humidity (% in the air)	50	50	50
Opacity (%)	>93	>99	>99



ROUGHNESS



ROUGHNESS

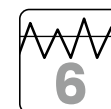

ROUGHNESS

GAMME RANGE

	120	260	320
 1000 x 700 mm	5720C	5721SC	5722SC

Ces gammes sont disponibles à la rame, à l'unité.
These ranges are available per ream, per unit.



82 CIE

HERITAGE NATURAL WHITE



REBECCA Studio

Un grain de caractère qui fait la différence. Heritage Natural White, d'une blancheur de 82 CIE, offre une base chaleureuse et un confort de lecture unique pour tous types de textes et d'images. Sa texture feutrée, double face, ajoute une dimension tactile agréable, incitant les lecteurs à explorer chaque page avec enthousiasme. Heritage Natural White se prête à l'impression offset, accepte le gaufrage et la dorure à chaud et s'adapte aussi aux différentes techniques de finition.

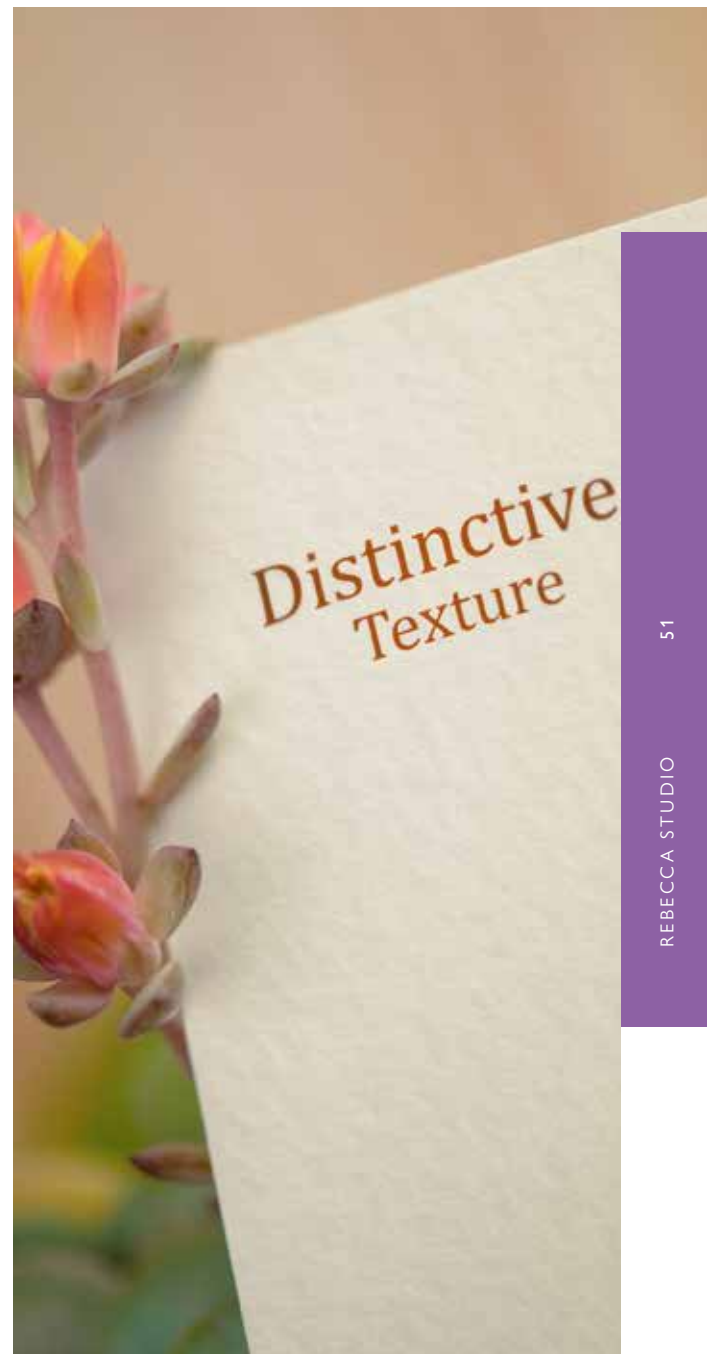
A characterful grain that makes all the difference. Heritage Natural White, with its 82 CIE whiteness, offers a warm base and unique reading comfort for all types of text and images. Its double-sided felted texture adds a pleasant tactile dimension, encouraging readers to explore each page with enthusiasm. Heritage Natural White is suitable for offset printing, embossing and hot foil stamping, as well as various finishing techniques.



HERITAGE NATURAL WHITE

	Ref.	Sizes (mm)	Gsm	Pallet Sizes (mm)	Stacks	Sheets / Pallet	Tabbed by	Pallet Net Weight (kg)
	5720C	1000 x 700	120g	1040 x 720	1	5 750	125	483
	5721SC	1000 x 700	260g	1040 x 720	1	2 700	100	491
	5722SC	1000 x 700	320g	1040 x 720	1	2 150	50	482

FICHE TECHNIQUE / code 460/462 TECHNICAL DATA SHEET

	Extra White			Ivory	
	100	120	300	100	120
Thickness (µm)	150	180	415	150	180
Bulk (cm³/g)	1.5	1.5	1.38	1.5	1.5
Bendtsen Roughness (ml/min)	600	600	750	600	600
Absolute Humidity (% H ₂ O)	6.5	6.5	7.0	6.5	6.5
Relative Humidity (% in the air)	50	50	60	50	50
Opacity (%)	91	96	99	91	94

GAMME RANGE



STOCKED ENVELOPES

CF. Page 57

	Extra White			Ivory	
	100	120	300	100	120
650 x 920 mm	4604C	4603C		4605C	4601C
650 x 920 mm	4604RC	4603RC		4605RC	4601RC
1000 x 700 mm			4619C		

REAMS

	Extra White		Ivory
	100		100
210 x 297 mm	4643C		4645C



150 CIE



ROUGHNESS

EMPIRE LAID EXTRA WHITE / IVORY

REBECCA Studio





Découvrez l'élégance intemporelle du papier vergé, un papier haut de gamme, filigrané, qui incarne le raffinement et le savoir-faire. Disponible en deux teintes, Extra White et Ivoire, il est parfaitement adapté à vos correspondances, invitations ou éditions de prestige. Sa texture noble et son apparence soignée offrent une expérience tactile unique, idéale pour marquer les esprits. Pour une présentation harmonieuse jusqu'au moindre détail, une gamme d'enveloppes coordonnées est disponible.

Un papier à découvrir, à toucher, à adopter sans attendre.





Discover the timeless elegance of laid paper, a premium watermarked paper that embodies refinement and craftsmanship. Available in two sophisticated shades, Extra White and Ivory, it is perfectly suited for your correspondence, invitations, or prestige editions. Its noble texture and refined appearance offer a unique tactile experience, ideal for leaving a lasting impression. For a harmonious presentation down to the finest detail, a range of matching envelopes is available. A paper to explore, to get your hands on and to adopt without delay.





EMPIRE LAID EXTRA WHITE / IVORY

Ref.	Sizes (mm)	Gsm	Pallet Sizes (mm)	Stacks	Sheets / Pallet	Tabbed by	Pallet Net Weight (kg)
EMPIRE LAID EXTRA WHITE							
 4604C	650 x 920	100g	960 x 690	1	8 000	250	479
 4603C	650 x 920	120g	960 x 690	1	7 000	250	502
 4604RC	650 x 920	100g	960 x 690	1	8 000	250	479
 4603RC	650 x 920	120g	960 x 690	1	7 000	250	502
 4619C	1000 x 700	300g	1040 x 720	1	2500	50	525

EMPIRE LAID IVORY

 4605C	650 x 920	100g	960 x 690	1	8 000	250	479
 4601C	650 x 920	120g	960 x 690	1	7 000	250	502
 4605RC	650 x 920	100g	960 x 690	1	8 000	250	479
 4601RC	650 x 920	120g	960 x 690	1	7 000	250	502

REAMS

Ref.	Sizes (mm)	Gsm	Sheets / Unit	Unit Weight (kg)	Unit / Box	Pallet Sizes (mm)	Units / Pallet	Pallet Net Weight (kg)
EMPIRE LAID EXTRA WHITE								
 4643C	210 x 297	100g	250	1,60	5	790 x 960	250	400
EMPIRE LAID IVORY								
 4645C	210 x 297	100g	250	1,60	5	790 x 960	250	400

STOCKED ENVELOPES**120 gsm****EMPIRE LAID EXTRA WHITE - ADHESIVE ENVELOPES**

Ref.	Sizes (mm)	Gsm	Flap	Window	Units / Box	Box / Weight (kg)	Pallet Sizes (mm)	Units / Pallet	Pallet Net Weight (kg)
4683C	DL - 110 x 220	120	adhesive	∅	250	1,83	120 x 80	135	260
4693C	C5 - 162 x 229	120	adhesive	∅	250	2,75	120 x 80	90	260

EMPIRE LAID IVORY - ADHESIVE ENVELOPES

Ref.	Sizes (mm)	Gsm	Flap	Window	Units / Box	Box / Weight (kg)	Pallet Sizes (mm)	Units / Pallet	Pallet Net Weight (kg)
4687C	DL - 110 x 220	120	adhesive	∅	250	1,83	120 x 80	135	260
4697C	C5 - 162 x 229	120	adhesive	∅	250	2,75	120 x 80	90	260

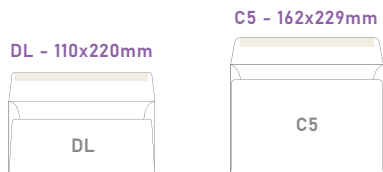

FICHE TECHNIQUE / code 442 TECHNICAL DATA SHEET

	120	240	350
Thickness (µm)	168	335	470
Bulk (cm ³ /g)	1.4	1.4	1.34
Bendtsen Roughness (ml/min)	600	800	1000
Absolute Humidity (% H ₂ O)	6.5	6.5	6.5
Relative Humidity (% in the air)	50	50	50
Opacity (%)	97	97	97



ROUGHNESS



ROUGHNESS

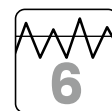

ROUGHNESS

GAMME RANGE

	120	240	350
 1000 x 700 mm	5800C	5801C	5802C

Ces gammes sont disponibles à la rame, à l'unité.
These ranges are available per ream, per unit.



100 CIE

VALORISE WHITE

REBECCA Studio

Le papier recyclé pour des histoires renouvelées. Valorise White est un papier non-couché qui laisse apparaître des fragments de végétaux. Il incarne une fusion entre exploration sensorielle et durabilité, où chaque fragment de végétaux apparents raconte une histoire de renouveau. Adapté aux techniques d'impression courantes et aux procédés de transformation, il offre une toile pour l'expression artistique tout en témoignant d'un engagement envers un monde plus vert et plus inspirant.

Green paper for a renewed story.

Valorise White is an uncoated, recycled paper that reveals plant fragments. It embodies a fusion of sensory exploration and sustainability, where each exposed flake of plant material tells a story of renewal. Suitable for common printing techniques and converting processes, it provides a canvas for artistic expression while demonstrating a commitment to a greener, more inspiring world.

Ce papier provient de la valorisation des résidus. Sa fabrication est réalisée avec le plus grand soin, et une attention particulière est portée à sa qualité. Cependant, vous pourrez occasionnellement — et plus souvent que dans d'autres papiers ne contenant pas de résidus — observer des particules non liées ou des points.



Par ailleurs, vous pourrez constater des variations de couleur entre les différents lots de matières premières ainsi qu'au cours de son utilisation, au fil du temps, avant et après l'application. Ces écarts sont dus aux résidus utilisés, qui sont, par nature, moins homogènes que les matières couramment employées dans la fabrication du papier. Ces nuances doivent être considérées comme des propriétés intrinsèques de ces catégories de papier et sont fondamentalement liées à l'aspect et au toucher naturels des papiers circulaires.

This paper is made from recovered residues. It is manufactured with the utmost care, and great attention is paid to its quality. However, you may occasionally — and more often than with other papers that do not contain residues — notice irregularities such as unbound particles or specks.

Furthermore, you may observe colour variations between different batches of raw materials and during its use over time, both before and after application. These differences are due to the residues used, which are by nature less homogeneous than the raw materials commonly employed in paper manufacturing. These variations should therefore be considered intrinsic properties of these types of papers and are fundamentally linked to the natural look and feel of circular papers.



VALORISE WHITE

	Ref.	Sizes (mm)	Gsm	Pallet Sizes (mm)	Stacks	Sheets / Pallet	Tabbed by	Pallet Net Weight (kg)
	5800C	1000 × 700	120g	1040 × 720	1	5 750	125	483
	5801C	1000 × 700	240g	1040 × 720	1	3 000	100	504
	5802C	1000 × 700	350g	1040 × 720	1	2 100	75	515

FICHE TECHNIQUE / code 443 TECHNICAL DATA SHEET

	120	240	350
Thickness (µm)	168	335	470
Bulk (cm ³ /g)	1.4	1.4	1.34
Bendtsen Roughness (ml/min)	600	800	1000
Absolute Humidity (% H ₂ O)	6.5	6.5	6.5
Relative Humidity (% in the air)	50	50	50
Opacity (%)	97	97	97



GAMME RANGE

	120	240	350
 1000 x 700 mm	5810SC	5811C	5812SC

Ces gammes sont disponibles à la rame, à l'unité.
These ranges are available per ream, per unit.



VALORISE NATURAL

REBECCA Studio

Le papier qui cultive le changement.

Valorise Natural, papier non-couché, partiellement issu de biodéchets, est un support à même de vous transporter dans une expérience unique, où éclats de végétaux et blancheur naturelle se mêlent harmonieusement.

Valorise Natural, disponible dans 3 grammages distincts se prête aux techniques d'impression traditionnelles et démontre aussi de bons résultats avec les principaux procédés de transformation.

Paper that cultivates change.

Valorise Natural, an uncoated paper made partly from bio-waste, is a material capable of taking you on a unique journey, where plant fragments and natural whiteness blend harmoniously.

Valorise Natural, available in 3 different grammages, lends itself to traditional printing techniques and performs well with the main converting processes.

Ce papier provient de la valorisation des résidus. Sa fabrication est réalisée avec le plus grand soin, et une attention particulière est portée à sa qualité. Cependant, vous pourrez occasionnellement — et plus souvent que dans d'autres papiers ne contenant pas de résidus — observer des particules non liées ou des points.



Par ailleurs, vous pourrez constater des variations de couleur entre les différents lots de matières premières ainsi qu'au cours de son utilisation, au fil du temps, avant et après l'application. Ces écarts sont dus aux résidus utilisés, qui sont, par nature, moins homogènes que les matières couramment employées dans la fabrication du papier. Ces nuances doivent être considérées comme des propriétés intrinsèques de ces catégories de papier et sont fondamentalement liées à l'aspect et au toucher naturels des papiers circulaires.

This paper is made from recovered residues. It is manufactured with the utmost care, and great attention is paid to its quality. However, you may occasionally — and more often than with other papers that do not contain residues — notice irregularities such as unbound particles or specks.

Furthermore, you may observe colour variations between different batches of raw materials and during its use over time, both before and after application. These differences are due to the residues used, which are by nature less homogeneous than the raw materials commonly employed in paper manufacturing. These variations should therefore be considered intrinsic properties of these types of papers and are fundamentally linked to the natural look and feel of circular papers.



VALORISE NATURAL

	Ref.	Sizes (mm)	Gsm	Pallet Sizes (mm)	Stacks	Sheets / Pallet	Tabbed by	Pallet Net Weight (kg)
	5810SC	1000 × 700	120g	1040 × 720	1	5750	125	483
	5811C	1000 × 700	240g	1040 × 720	1	3000	100	504
	5812SC	1000 × 700	350g	1040 × 720	1	2100	75	515

FICHE TECHNIQUE / code 444 TECHNICAL DATA SHEET

	120	240	350
Thickness (µm)	168	335	470
Bulk (cm ³ /g)	1.4	1.4	1.4
Bendtsen Roughness (ml/min)	600	800	1000
Absolute Humidity (% H ₂ O)	6.5	6.5	6.5
Relative Humidity (% in the air)	50	50	50
Opacity (%)	97	97	97



GAMME RANGE

	120	240	350
 1000 x 700 mm	5820C	5821SC	5822SC

Ces gammes sont disponibles à la rame, à l'unité.
These ranges are available per ream, per unit.



VALORISE IVORY

REBECCA Studio

La force de la nature capturée dans un papier.

Valorise Ivory est une invitation à explorer un monde d'authenticité et d'engagement écologique. Ce papier non-couché, partiellement élaboré à partir de matériau organique, raconte une histoire de résilience et de renaissance, imprégnée des richesses de la nature. Esthétique, Valorise Ivory convient parfaitement aux couvertures de livres dans sa version 350 g/m², et reste idéalement adapté aux projets d'édition, invitations ou menus dans ses versions plus légères.

The power of nature captured on paper.

Valorise Ivory is an invitation to explore a world of authenticity and ecological commitment. This uncoated paper, partly made from organic material, tells a story of resilience and rebirth, imbued with the riches of nature. Aesthetically pleasing, Valorise Ivory is perfectly suited to book covers in its 350 gsm version, and remains ideally well adapted to publishing projects, invitations or menus in its lighter versions.

Ce papier provient de la valorisation des résidus. Sa fabrication est réalisée avec le plus grand soin, et une attention particulière est portée à sa qualité. Cependant, vous pourrez occasionnellement — et plus souvent que dans d'autres papiers ne contenant pas de résidus — observer des particules non liées ou des points.



Par ailleurs, vous pourrez constater des variations de couleur entre les différents lots de matières premières ainsi qu'au cours de son utilisation, au fil du temps, avant et après l'application. Ces écarts sont dus aux résidus utilisés, qui sont, par nature, moins homogènes que les matières couramment employées dans la fabrication du papier. Ces nuances doivent être considérées comme des propriétés intrinsèques de ces catégories de papier et sont fondamentalement liées à l'aspect et au toucher naturels des papiers circulaires.

This paper is made from recovered residues. It is manufactured with the utmost care, and great attention is paid to its quality. However, you may occasionally — and more often than with other papers that do not contain residues — notice irregularities such as unbound particles or specks.

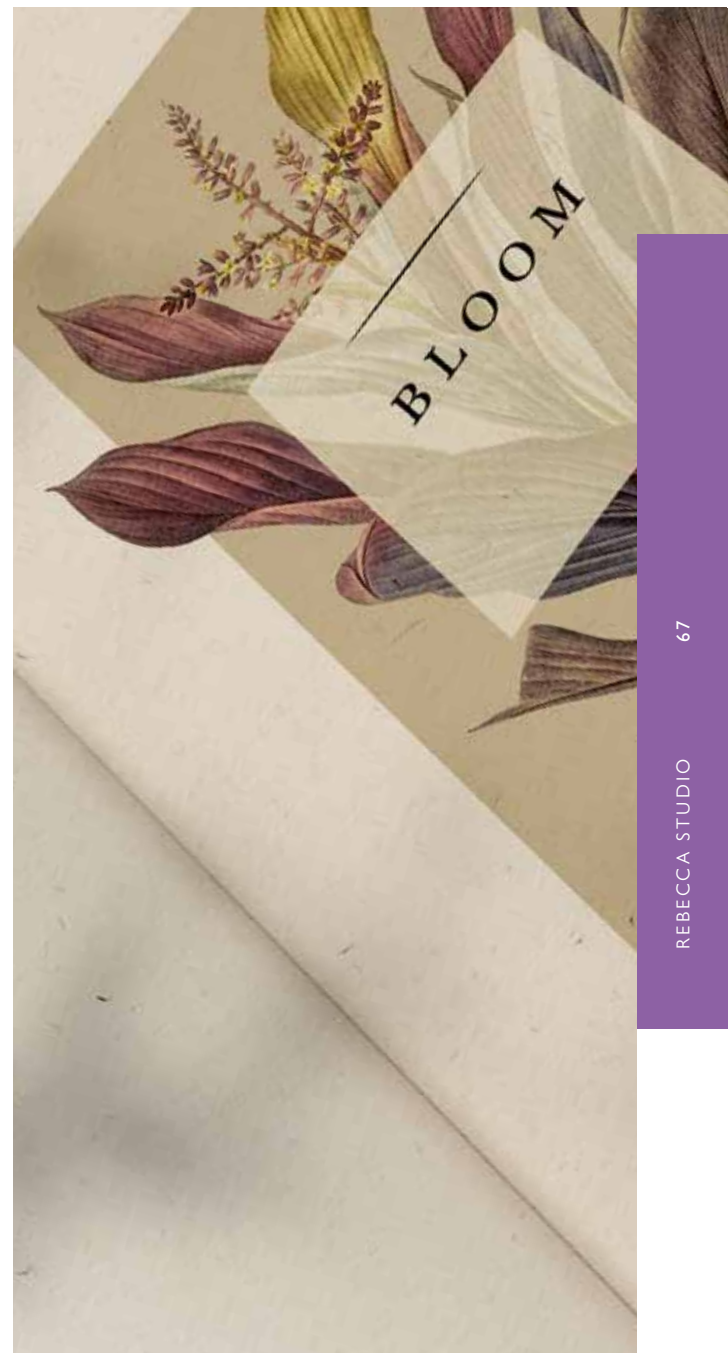
Furthermore, you may observe colour variations between different batches of raw materials and during its use over time, both before and after application. These differences are due to the residues used, which are by nature less homogeneous than the raw materials commonly employed in paper manufacturing. These variations should therefore be considered intrinsic properties of these types of papers and are fundamentally linked to the natural look and feel of circular papers.



VALORISE IVORY

	Ref.	Sizes (mm)	Gsm	Pallet Sizes (mm)	Stacks	Sheets / Pallet	Tabbed by	Pallet Net Weight (kg)
	5820C	1000 × 700	120g	1040 × 720	1	5 750	125	483
	5821SC	1000 × 700	240g	1040 × 720	1	3 000	100	504
	5822SC	1000 × 700	350g	1040 × 720	1	2 100	75	515



FICHE TECHNIQUE TECHNICAL DATA SHEET

	Bouleau		Ecru		Muscat	
	120	300	120	300	120	300
Thickness (µm)	142	340	142	340	142	340
Bulk (cm ³ /g)	1.18	1.13	1.18	1.13	1.18	1.13
Bekk Smoothness (s)	15	15	15	15	15	15
Absolute Humidity (% H ₂ O)	6.5	6.5	6.5	6.5	6.5	6.5
Relative Humidity (% in the air)	50	50	50	50	50	50

GAMME RANGE

	Bouleau		Ecru		Muscat	
	120	300	120	300	120	300
700 x 1000 mm	27101C		27103C		27105C	
1000 x 700 mm	27102C		27104C		27106C	

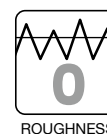

ECO KRAFT BOULEAU ECO KRAFT ECRU ECO KRAFT MUSCAT

REBECCA Studio

Les papiers naturels pour planter des phrases.
Rebecca Eco Kraft se sont des supports recyclés constitués de 50 % de fibres recyclées et de 50 % de fibres vierges, certifiées FSC®. Conçue pour des impressions offset, cette gamme de papiers est aussi apte à l'impression numérique HP Indigo. 100% recyclables, les papiers Rebecca Eco Kraft sont des concentrés de nature, idéaux pour des marques éco-responsables qui souhaitent se différencier et intensifier leur démarche dans l'économie circulaire. Le registre des teintes se module autour de trois références, Bouleau, Ecrû et Muscat.
Disponible en 120 g/m² et 300 g/m².



Natural papers for planting sentences.
Rebecca Eco Kraft is a range of recycled papers made from 50 % recycled fibres and 50 % virgin fibres, FSC® certified. Designed for offset printing, this range of papers is also suitable for HP Indigo digital printing. 100% recyclable, Rebecca Eco Kraft papers are concentrates of nature, ideal for eco-responsible brands wishing to differentiate themselves and intensify their approach in the circular economy. The range of colours is based on three references, Bouleau, Ecrû and Muscat.
Available in 120 gsm and 300 gsm.





ECO KRAFT BOULEAU / ECRU / MUSCAT

Ref.	Sizes (mm)	Gsm	Pallet Sizes (mm)	Stacks	Sheets / Pallet	Tabbed by	Pallet Net Weight (kg)
------	------------	-----	-------------------	--------	-----------------	-----------	------------------------



ECO KRAFT BOULEAU

 27101C	700 x 1000	120g	1040 x 720	1	7 000	200	588
 27102C	1000 x 700	300g	1040 x 720	1	3 000	100	630

ECO KRAFT ECRU

 27103C	700 x 1000	120g	1040 x 720	1	7 000	200	588
 27104C	1000 x 700	300g	1040 x 720	1	3 000	100	630

ECO KRAFT MUSCAT

 27105C	700 x 1000	120g	1040 x 720	1	7 000	200	588
 27106C	1000 x 700	300g	1040 x 720	1	3 000	100	630

DECKLES EDGES

FICHE TECHNIQUE / code 3107 - 3201 TECHNICAL DATA SHEET



















	130	300
Thickness (µm)	212	450
Bulk* (cm ³ /g)	1.63	1.50
Bendtsen roughness (ml/min)	1000	1400
Absolute Humidity (% H ₂ O)	6.5%	6.75%
Relative Humidity (% in the air)	50%	50%
Opacity* (%)	91	>99

*Valeur considérée comme indicative. non comme objectif.

* Specs are indicative values, not targets..



GAMME RANGE Cards - Sheets

		300
	80 x 130	E3201C94007.0300
	80 x 260	E3201C94055.0300
	92 x 135	E3201C94006.0300
	92 x 270	E3201C94054.0300
	101 x 158	E3201C94005.0300
	116 x 171	E3201C94003.0300
	116 x 225	E3201C94057.0300
	116 x 342	E3201C94013.0300
	130 x 260	E3201C94022.0300
	138 x 191	E3201C94002.0300
	138 x 382	E3201C94064.0300
	150 x 300	E3201C94094.0300
	158 x 200	E3201C94001.0300
	160 x 130	E3201C94053.0300
	184 x 135	E3201C94012.0300
	232 x 171	E3201C94015.0300
	276 x 191	E3201C94017.0300
	316 x 200	E3201C94051.0300



98 CIE



STOCKED ENVELOPES

CF. Page 77

DECKLES EDGES

REBECCA Studio

Idéales pour les faire-part de mariage, les cartes de vœux, les documents officiels ou la correspondance personnalisée, nos papiers de papeterie haut de gamme allient élégance et tradition. Avec leurs bords frangés délicats, ces cartes confèrent un charme intemporel à vos messages les plus chers. Les cartes peuvent être accompagnées d'une enveloppe assortie, fabriquée à partir du même papier de haute qualité, garantissant ainsi une harmonie parfaite en termes de texture, de teinte et de finition. Que vous célébriez une occasion spéciale ou que vous créiez une invitation mémorable, ces ensembles coordonnés offrent sophistication et authenticité jusque dans les moindres détails. Une touche de distinction – du papier à l'enveloppe !









Perfectly suited for wedding invitations, wishing cards, official documents or personalised correspondence, our fine stationery papers combine elegance and tradition. With their delicate deckle edges, these cards bring a timeless charm to your most meaningful messages. Cards can be paired with a matching envelope made from the same high-quality paper – ensuring perfect harmony in texture, shade and finish. Whether you're marking a special occasion or creating a memorable invitation, these coordinated sets offer sophistication and authenticity down to the last detail.

A touch of distinction – from paper to envelope!



DECKLES EDGES

GAMME RANGE Envelopes

		300
	90 x 140	E3107C91098.0130
	102 x 145	E3107C91095.0130
	110 x 170	E3107C91110.0130
	120 x 184	E3107C91102.0130
	120 x 184	E3107C91073.0130
	140 x 140	E3107C91096.0130
	146 x 200	E3107C91117.0130
	160 x 160	E3107C91129.0130
	165 x 208	E3107C91116.0130

DECKLES EDGES

Ref.	Open Size (mm)	Gsm	Folded Size (mm)	Tabbed by	Description
CARDS - Sheets					
E3201C94007.0300	80 x 130	300g	/	500	1025K Card single
E3201C94055.0300	80 x 260	300g	80 x 130	500	1025KLD Card long double
E3201C94006.0300	92 x 135	300g	/	500	1070K Card single
E3201C94054.0300	92 x 270	300g	92 x 135	500	1070KLD Card long double
E3201C94005.0300	101 x 158	300g	/	500	1090K Card single
E3201C94003.0300	116 x 171	300g	/	500	1100K Card single
E3201C94057.0300	116 x 225	300g	/	500	K2558 Small cards 25 x 58 mm
E3201C94013.0300	116 x 342	300g	116 x 171	500	1100KLD Card long double
E3201C94022.0300	130 x 260	300g	130 x 130	500	1014KLD Card long double
E3201C94002.0300	138 x 191	300g	/	500	1120K Card single
E3201C94064.0300	138 x 382	300g	138 x 191	500	1120KLD Card long double
E3201C94094.0300	150 x 300	300g	150 x 150	500	1016KLD Card long double
E3201C94001.0300	158 x 200	300g	/	500	1140K Card single
E3201C94053.0300	160 x 130	300g	80 x 130	500	1025KBD Card wide double
E3201C94012.0300	184 x 135	300g	92 x 135	500	1070KBD Card wide double
E3201C94015.0300	232 x 171	300g	116 x 171	500	1100KBD Card wide double
E3201C94017.0300	276 x 191	300g	138 x 191	500	1120KBD Card wide double
E3201C94051.0300	316 x 200	300g	158 x 200	500	1140KBD Card wide double

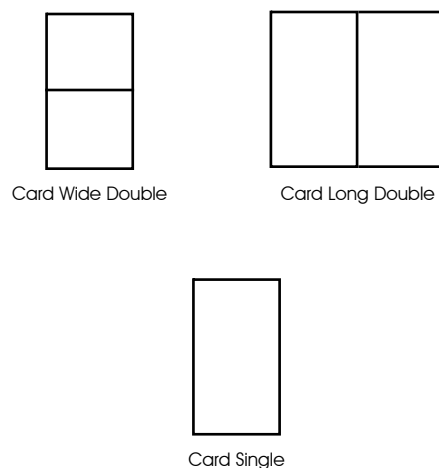

DECKLES EDGES

Ref.	Size (mm)	Gsm	Tabbed by	Description
ENVELOPES				
E3107C91098.0130	90 × 140	130g	500	1025CS Gummed
E3107C91095.0130	102 × 145	130g	500	1070CS Gummed
E3107C91110.0130	110 × 170	130g	500	1090CS Gummed
E3107C91102.0130	120 × 184	130g	500	1100CS Gummed
E3107C91073.0130	120 × 184	130g	500	1100CS Not Gummed
E3107C91096.0130	140 × 140	130g	500	1014CS Gummed
E3107C91117.0130	146 × 200	130g	500	1120CS Gummed
E3107C91129.0130	160 × 160	130g	500	1016CS Gummed
E3107C91116.0130	165 × 208	130g	500	1140CS Gummed

CARDS MATCHING ENVELOPES

Cards Article code	Envelopes Article code
E3201C94003.0300	E3107C91073.0130
E3201C94013.0300	
E3201C94015.0300	E3107C91102.0130
E3201C94006.0300	
E3201C94012.0300	E3107C91095.0130
E3201C94054.0300	
E3201C94022.0300	E3107C91096.0130
E3201C94007.0300	
E3201C94053.0300	E3107C91098.0130
E3201C94055.0300	
E3201C94005.0300	
E3201C94050.0300	E3107C91110.0130
E3201C94052.0300	
E3201C94001.0300	E3107C91116.0130
E3201C94051.0300	
E3201C94002.0300	
E3201C94017.0300	E3107C91117.0130
E3201C94064.0300	
E3201C94094.0300	E3107C91129.0130

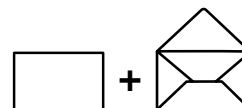

C-OPAK
SMART PRINT



REBECCA Thin

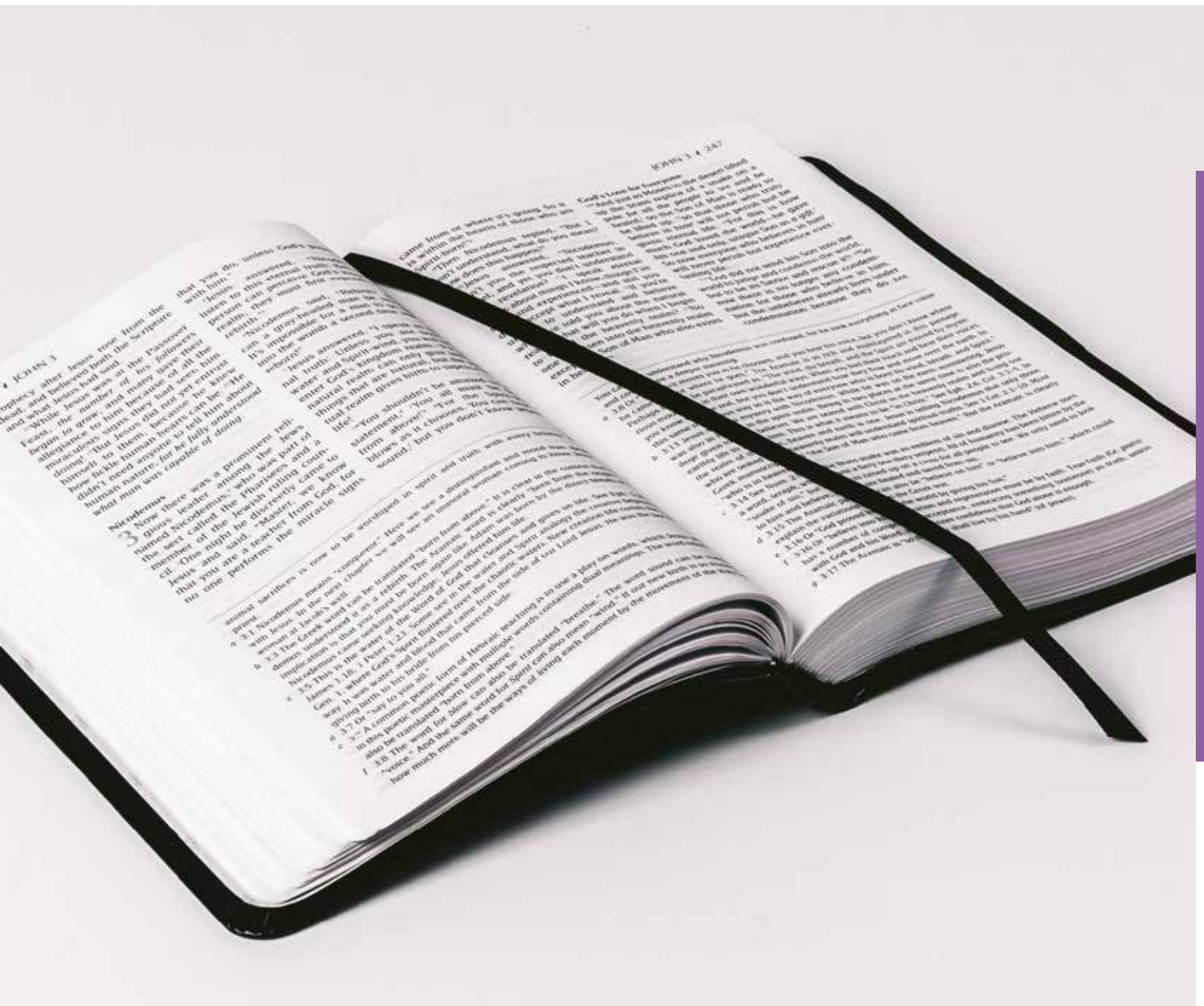



FICHE TECHNIQUE / code 780/155

TECHNICAL DATA SHEET

	C-OPAK				SMART PRINT		
	40	45	50	60	50	60	72
Thickness (µm)	50	56	63	75	69	83	97
Bulk (cm ³ /g)	1.25	1.25	1.25	1.25	1.38	1.38	1.35
Bekk Smoothness (s)	80	80	80	80	220*	220*	180*
Absolute Humidity (%H ₂ O)	5.3	5.3	5.3	5.3	4.5	4.8	5.0
Relative Humidity (% in the air)	42	42	42	42	30	35	38
Opacity (%)	82	84	86	89	85	87.5	91

* Bendtsen Roughness (ml/min)



110 CIE



168 CIE

GAMME RANGE

SMART PRINT	50	60	70
450 x 320 mm	1934C		
430 x 610 mm			3963C
430 x 610 mm			3965C
450 x 640 mm	2818SC	2823SC	
450 x 640 mm		3996SC	
460 x 640 mm		3941C	3942C
630 x 880 mm	2856C		
880 x 630 mm	2857C		
880 x 630 mm			3968C
650 x 920 mm	2819SC		



C-OPAK / SMART PRINT

REBECCA Thin

C-Opak

Spécialement conçu pour la fabrication de livres à forte pagination. Il présente une opacité renforcée, exceptionnelle pour son épaisseur. Sa teinte chaude, améliore le confort de lecture et son toucher très soyeux rend la préhension et le mouvement des pages très agréable. Innovant, il s'imprime aussi bien sur presse jet d'encre haute vitesse qu'en rotative ou presse offset.

Smart Print Papers

Avec une blancheur élevée de 168 CIE ainsi qu'une bonne opacité, cette gamme de papier se décline en papier offset & preprint ainsi qu'en ramettes pour la bureautique. Garantie pour un parfait passage en impression laser.

C-Opak







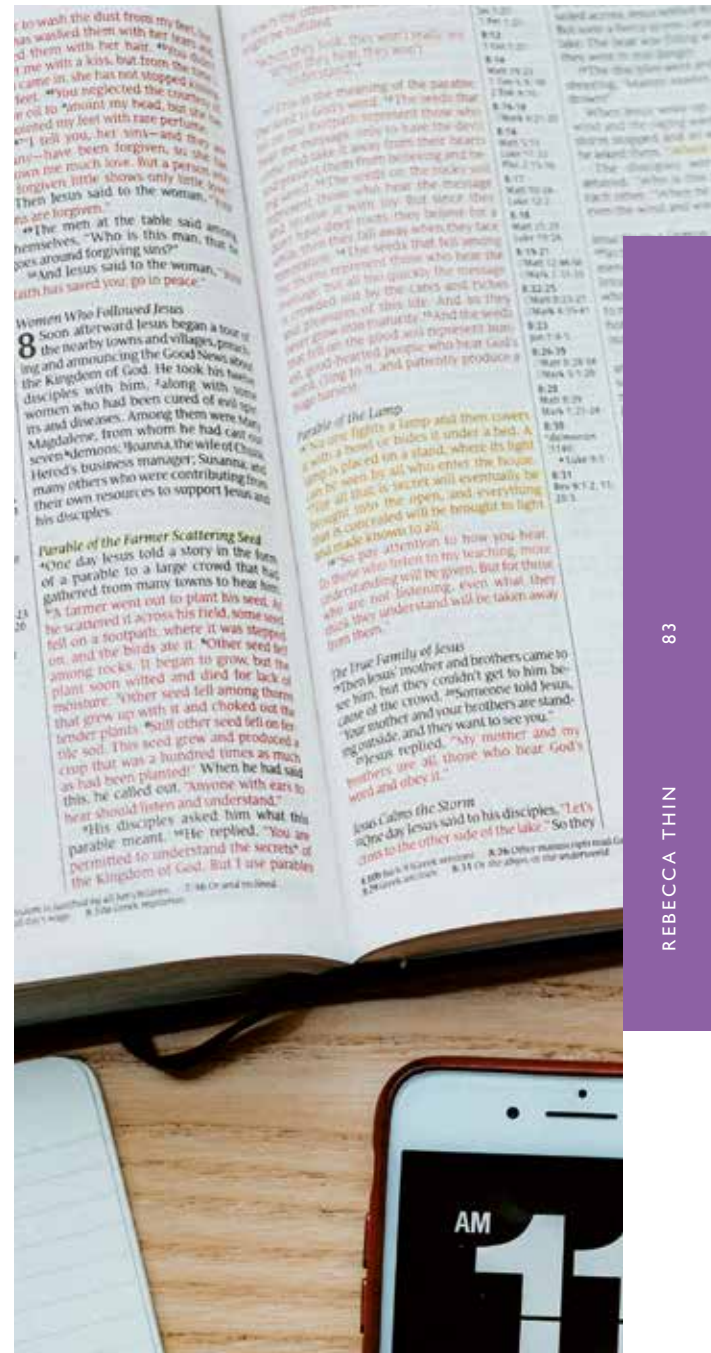





Specially designed to produce high-pagination books. It has a reinforced opacity, exceptional for its thickness. Its warm colour improves reading comfort, and its very silky touch makes it very pleasant to hold and move the pages. Innovative, it can be printed on high-speed inkjet presses as well as on rotary or offset presses.

Smart Print Papers

With a high whiteness of 168 CIE as well as a good opacity, this range of paper is available in offset & preprint papers as well as in reams for office use. Guaranteed to perfectly pass through laser printing.



SMART PRINT

Ref.	Sizes (mm)	Gsm	Pallet Sizes (mm)	Stacks	Sheets / Pallet	Tabbed by	Pallet Net Weight (kg)
SMART PRINT							
 1934C	450 x 320	50g	940 x 670	4	60 000	1 000	432
 3963C	430 x 610	70g	940 x 670	2	20 000	500	367
 3965C	430 x 610	70g	920 x 660	2	28 000	500	514
 2818SC	450 x 640	50g	940 x 670	2	30 000	500	432
 2823SC	450 x 640	60g	940 x 670	2	22 000	500	380
 3996SC	450 x 640	60g	960 x 690	2	32 000	500	553
 3941C	460 x 640	60g	940 x 670	2	24 000	500	424
 3942C	460 x 640	70g	940 x 670	2	22 000	500	453
 2856C	630 x 880	50g	920 x 660	1	17 500	500	485
 2857C	880 x 630	50g	920 x 660	1	17 500	500	485
 3968C	880 x 630	70g	920 x 660	1	14 000	250	543
 2819SC	650 x 920	50g	960 x 690	1	17 500	500	523

ICY ORIGINAL
CLAIRJET 400 BRIGHT
CLAIRJET 400 SMOOTH
EVERJET PREMIUM



REBECCA High Speed Inkjet







FICHE TECHNIQUE / code 748 TECHNICAL DATA SHEET

	80	90	100	120	140	160
Thickness (µm)	81	91	100	118	137	157
Bulk (cm ³ /g)	1.01	1.01	1.00	0.98	0.98	0.98
Bekk Smoothness (s)	220	220	220	200	180	180
Absolute Humidity (%H ₂ O)	5.8	5.8	5.8	5.8	5.8	5.8
Relative Humidity (% in the air)	47	47	47	47	47	47
Opacity (%)	88	91	93.5	95.5	98	>99

GAMME RANGE

	80	90	120	160
 210 x 297 mm	11020C	11021C	11022C	11023C
 450 x 320 mm	4701C	4702C	4703C	

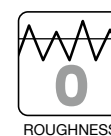

ICY ORIGINAL







REBECCA High Speed Inkjet

Icy Original est le choix idéal pour les travaux à forte couverture d'encre, sur une surface brillante. Un séchage d'encre très rapide, une densité colorimétrique élevée et un rendu d'impression parfait en font le support adapté à la réalisation de marketing direct, de littérature technique ou scolaire. Icy Original est proposé dans une blancheur de 151 CIE, optimale pour un rendu chromatique équilibré.

Icy Original is the perfect choice for jobs with high ink coverage on a glossy surface. Very fast ink drying, high colour density and perfect print results make it ideal for direct marketing as well as for technical and school literature. Icy Original is available in a whiteness of 151 CIE, optimum for balanced colour rendition.



ICY ORIGINAL

	Ref.	Sizes (mm)	Gsm	Pallet Sizes (mm)	Stacks	Sheets / Pallet	Tabbed by	Pallet Net Weight (kg)
	11020C	210 x 297	80g	960 x 790	-	125 000	500	624
	11021C	210 x 297	90g	960 x 790	-	100 000	500	562
	11022C	210 x 297	120g	960 x 790	-	50 000	250	374
	11023C	210 x 297	160g	960 x 790	-	50 000	250	499
	4701C	450 x 320	80g	940 x 670	4	50 000	500	576
	4702C	450 x 320	90g	940 x 670	4	44 000	500	571
	4703C	450 x 320	120g	940 x 670	4	35 000	250	605

CLAIRJET 400 BRIGHT



FICHE TECHNIQUE / code 143/808 TECHNICAL DATA SHEET

	70	80	90	120	160	200	300
Thickness (µm)	91	104	117	156	208	260	375
Bulk (cm³/g)	1.30	1.30	1.30	1.30	1.30	1.30	1.25
Bendtsen roughness (ml/min)	145	145	145	145	145	145	145
Absolute Humidity (%H ₂ O)	5.6	5.6	5.6	5.6	5.5	5.5	5.5
Relative Humidity (% in the air)	45	45	45	45	44	44	44
Opacity (%)	93	95	96	97	>99	>99	>99

GAMME RANGE

	70	80	90	120	160	200	300
210 x 297 mm		11000C	11002C				
420 x 297 mm		11001C	11003C				
450 x 320 mm	19301C	45321C	28911C	19581C	19571C	19631C	19611C



CLAIRJET 400 BRIGHT











REBECCA High Speed Inkjet

Clairjet 400 Bright est le papier polyvalent développé pour l'impression jet d'encre. Ce papier de haute blancheur, 170 CIE, est compatible avec les encres dyes et pigmentaires. Clairjet 400 Bright présente une stabilité dimensionnelle élevée, une absence de déformation après dépose de l'encre et un séchage rapide. Clairjet 400 Bright convient parfaitement à l'impression de documents transactionnels ou promotionnels.

Clairjet 400 Bright is a multifunctional paper developed for Inkjet printing. This high whiteness paper, 170 CIE, is compatible with dye and pigment inks. Clairjet 400 Bright offers high dimensional stability, no deformation after ink application and quick drying time. Clairjet 400 Bright is ideal for printing transactional or promotional documents.



CLAIRJET 400 BRIGHT



	Ref.	Sizes (mm)	Gsm	Pallet Sizes (mm)	Stacks	Sheets / Pallet	Tabbed by	Pallet Net Weight (kg)
	11000C	210 x 297	80g	960 x 790	-	125 000	500	624
	11002C	210 x 297	90g	960 x 790	-	100 000	500	561
	11001C	420 x 297	80g	960 x 790	-	62 500	500	624
	11003C	420 x 297	90g	960 x 790	-	50 000	500	562
	1930IC	450 x 320	70g	940 x 670	4	50 000	500	504
	4532IC	450 x 320	80g	940 x 670	4	44 000	500	507
	2891IC	450 x 320	90g	940 x 670	4	40 000	500	519
	1958IC	450 x 320	120g	940 x 670	4	30 000	250	519
	1957IC	450 x 320	160g	940 x 670	4	20 000	250	461
	1963IC	450 x 320	200g	940 x 670	4	18 000	250	519
	1961IC	450 x 320	300g	940 x 670	4	10 000	125	432



FICHE TECHNIQUE / code 139 TECHNICAL DATA SHEET

	80	90
Thickness (µm)	96	108
Bulk (cm ³ /g)	1.20	1.20
Bekk Smoothness (s)	80	80
Absolute Humidity (%H ₂ O)	5.6	5.6
Relative Humidity (% in the air)	45	45
Opacity (%)	93	94

GAMME RANGE

	80	90
 210 x 297 mm	11024C	11026C
 450 x 320 mm	11025C	11027C

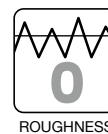

CLAIRJET 400 SMOOTH

REBECCA High Speed Inkjet

Clairjet 400 Smooth est un papier mat et lisse, fabriqué à partir de fibres vierges et présentant une main de 1,20.

Il a été développé spécifiquement pour les impressions jet d'encre.

Ce papier est idéal pour des impressions en noir et en couleur et présente une couverture d'encre moyenne à élevée.



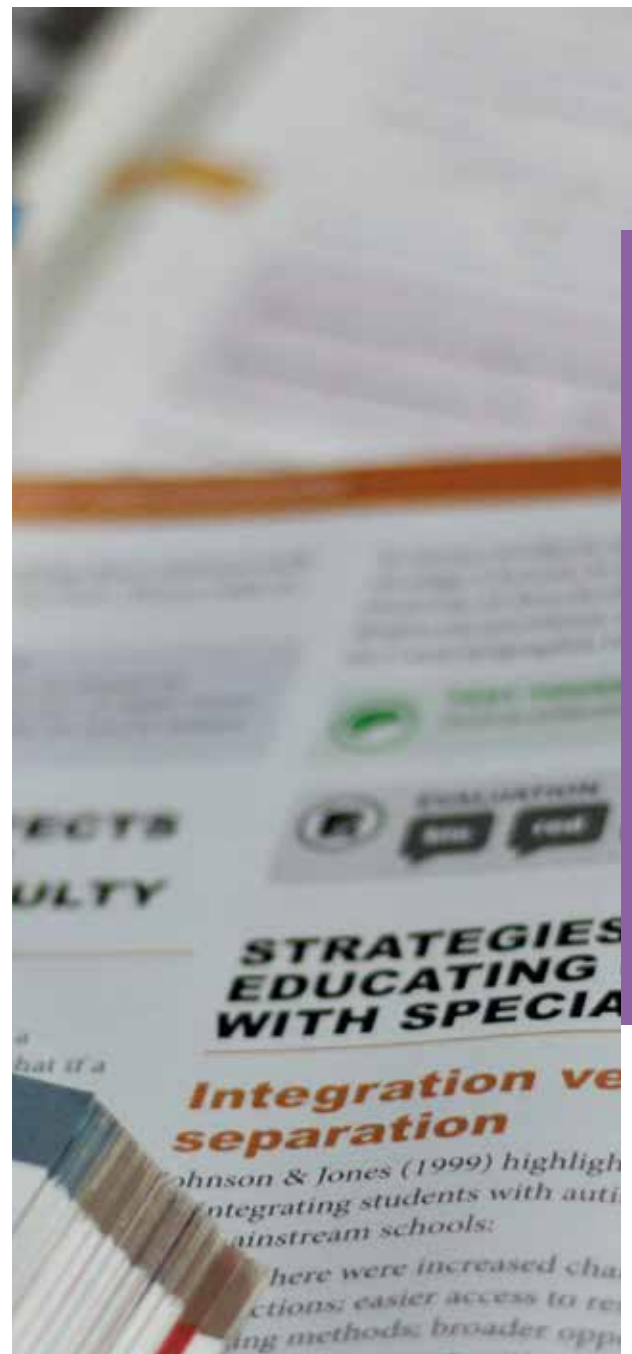

Clairjet 400 Smooth is a smooth, matt paper made from virgin fibres with a basis weight of 1.20 g/m².

It has been developed specifically for inkjet printing.

This paper is ideal for both black-and-white and colour printing and offers medium to high ink coverage.



CLAIRJET400 SMOOTH

	Ref.	Sizes (mm)	Gsm	Pallet Sizes (mm)	Stacks	Sheets / Pallet	Tabbed by	Pallet Net Weight (kg)
	11024C	210 x 297	80g	960 x 790	-	125 000	500	625
	11026C	210 x 297	90g	960 x 790	-	100 000	500	562
	11025C	450 x 320	80g	1000 x 690	4	40 000	500	456
	11027C	450 x 320	90g	1000 x 690	4	40 000	500	520



FICHE TECHNIQUE / code 792 TECHNICAL DATA SHEET

	80	90	100	120	160
Thickness (µm)	96	108	120	144	192
Bulk (cm ³ /g)	1.20	1.20	1.20	1.20	1.20
Bendtsen roughness (ml/min)	150	150	150	150	150
Absolute Humidity (%H ₂ O)	5.5	5.5	5.5	5.5	5.5
Relative Humidity (% in the air)	44	44	44	44	44
Opacity (%)	93	95	96	>99	>99

GAMME RANGE

	80	90	100	160
210 x 297 mm	11016C	11017C	11018C	11019C
450 x 320 mm	1920IC	1922IC	1613C	



www.blauer-engel.de/uz14a



The mark of responsible forestry



Please collect used paper for recycling



135 CIE



ROUGHNESS

EVERJET PREMIUM







REBECCA High Speed Inkjet

Everjet Premium est fabriqué entièrement à partir de fibres recyclées. Ce papier multi-usage à la blancheur naturelle de 135 CIE, est particulièrement approprié aux impressions transactionnelles et aux documents promotionnels. La qualité de coupe de ce papier est excellente et le respect précis des dimensions permet un passage fiable dans les machines pour une productivité maximale.

Everjet Premium is made entirely from recycled fibres. This versatile paper, with a natural whiteness of 135 CIE, is particularly suited to transactional printing and promotional documents. The slitting quality of this paper is excellent, and its precise dimensional accuracy means that it runs reliably through the machines for maximum productivity.



EVERJET PREMIUM

	Ref.	Sizes (mm)	Gsm	Pallet Sizes (mm)	Stacks	Sheets / Pallet	Tabbed by	Pallet Net Weight (kg)
	11016C	210 x 297	80g	960 x 790	-	125 000	500	624
	11017C	210 x 297	90g	960 x 790	-	100 000	500	562
	11018C	210 x 297	100g	960 x 790	-	80 000	500	499
	11019C	210 x 297	160g	960 x 790	-	50 000	250	499
	1920IC	450 x 320	80g	940 x 670	4	46 000	500	530
	1922IC	450 x 320	90g	940 x 670	4	42 000	500	545
	1613C	450 x 320	100g	940 x 670	4	30 000	500	432

GENYOUS® WHITE
GENYOUS® BLACK INTENSE
TROPHÉE / PAPAGO
TROPHÉE NÉON
BENGALI



REBECCA Color

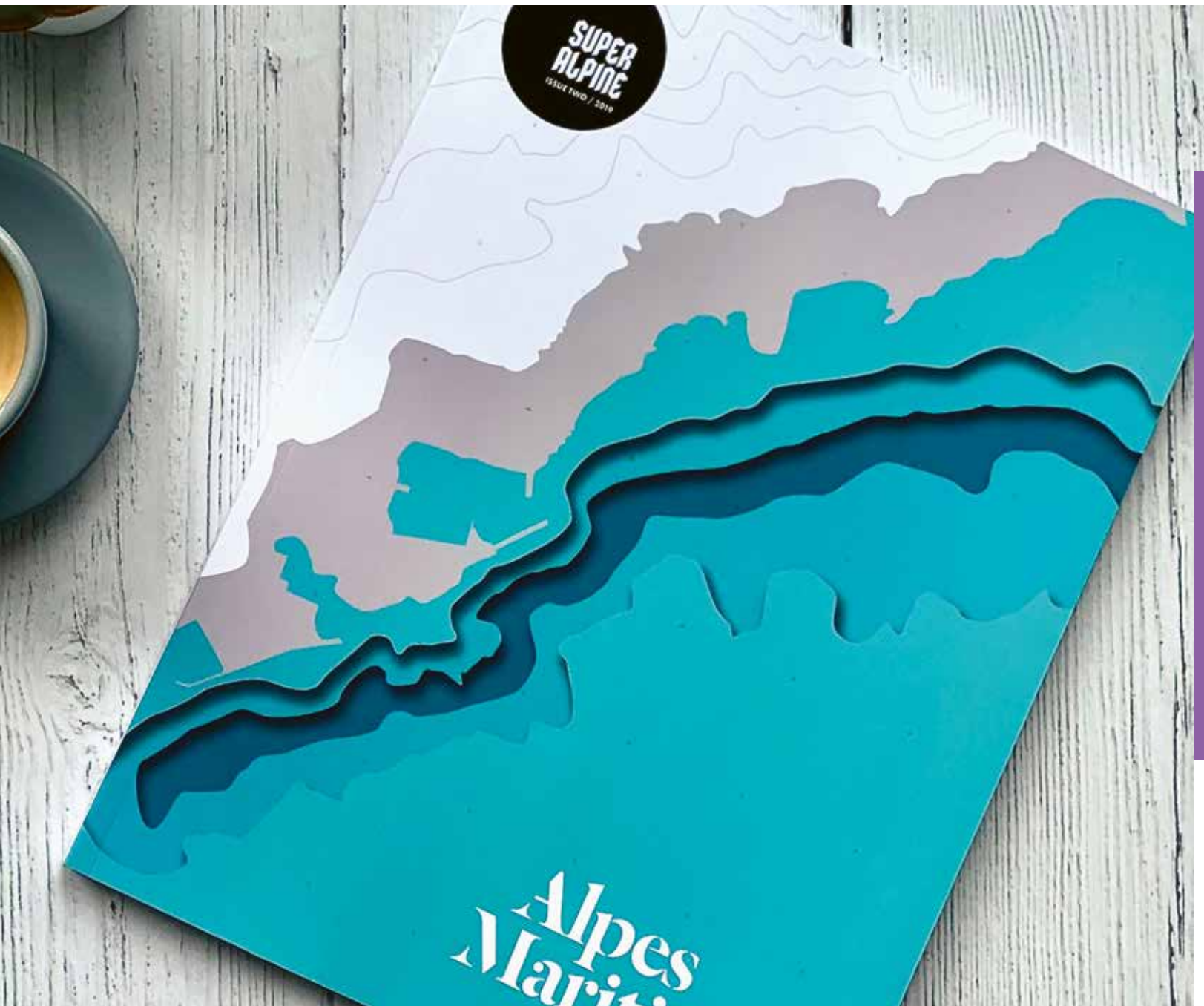





FICHE TECHNIQUE / code 308 TECHNICAL DATA SHEET

	300	350	400
Thickness (µm)	350	405	450
Bulk (cm ³ /g)	1.16	1.16	1.12
Bendtsen Roughness (ml/min)	150	150	150
Opacity (%)	>99	>99	>99

GAMME RANGE

	300	350	400
 460 x 320 mm	4028C	4029C	4030C
 530 x 750 mm	4038C	4039C	4040C



GENYOUS® WHITE

REBECCA Color

GenYous® White est un papier 100% cellulose ECF, non couché, avec un état de surface exceptionnel garantissant une solution unique pour impression numérique (toner sec / toner liquide) et offset.





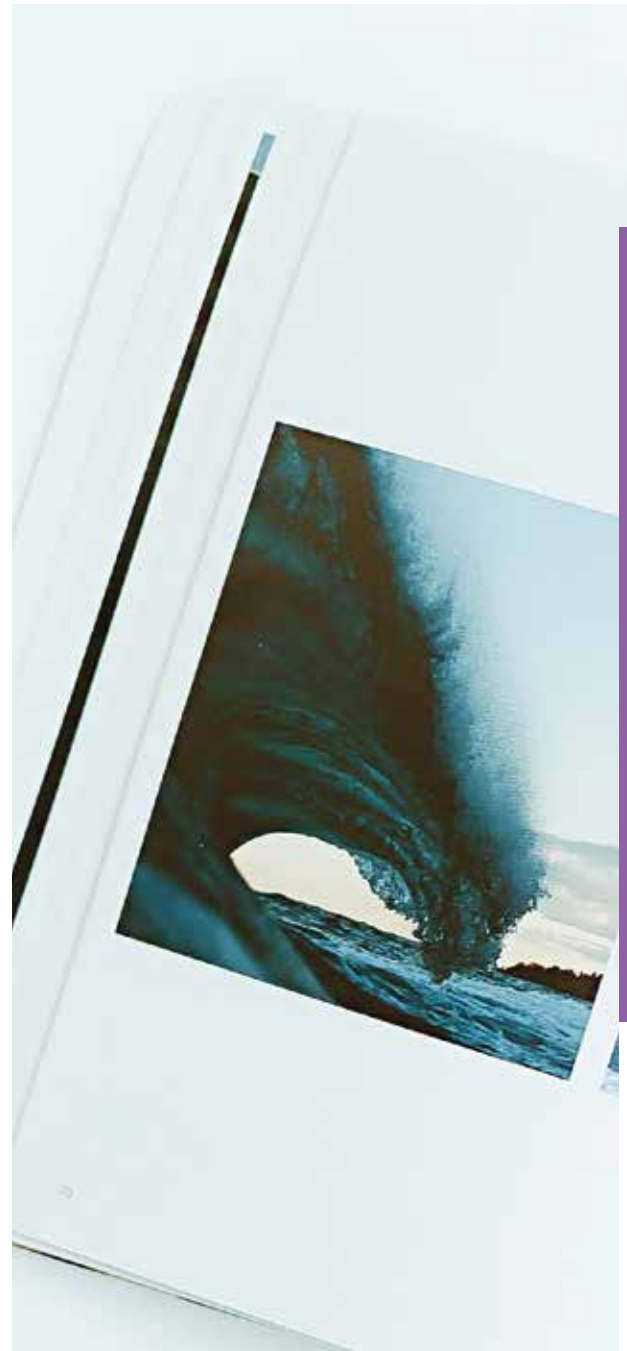

GenYous® White est aussi la combinaison optimale, d'une main exceptionnelle (épaisseur calibrée), d'une blancheur élevée et d'un toucher sensuel. Cette gamme est en mesure de couvrir un panel d'applications variées comme l'édition, les brochures et catalogues, les cartes de voeux, les invitations, les menus et tête de lettres.

GenYous® White is 100% ECF cellulose paper, uncoated, with an exceptional surface finish, guaranteeing a unique solution for digital printing (dry toner/liquid toner) and offset printing.

GenYous® White is also the optimum combination of exceptional strength (calibrated thickness), high whiteness and a sensual feel. This range covers a wide range of applications, including publishing, brochures and catalogues, greetings cards, invitations, menus, and letterheads.



GENYOU[®] WHITE

	Ref.	Sizes (mm)	Gsm	Pallet Sizes (mm)	Stacks	Sheets / Pallet	Tabbed by	Pallet Net Weight (kg)
	4028C	460 x 320	300g	960 x 660	4	10 000	125	442
	4029C	460 x 320	350g	960 x 660	4	9 500	125	489
	4030C	460 x 320	400g	960 x 660	4	8 000	125	471
	4038C	530 x 750	300g	1080 x 760	2	5 000	125	596
	4039C	530 x 750	350g	1080 x 760	2	4 800	100	668
	4040C	530 x 750	400g	1080 x 760	2	4 000	100	636



FICHE TECHNIQUE TECHNICAL DATA SHEET

	140	200	300	400	600
Thickness (µm)	170	230	340	440	660
Bulk (cm ³ /g)	1.21	1.15	1.13	1.10	1.10
Bendtsen Roughness (ml/min)	300	300	300	300	300
Absolute Humidity (% H ₂ O)	6.7	6.8	6.8	6.8	6.8
Relative Humidity (% in the air)	51.5	51.5	51.5	51.5	51.5

GAMME RANGE

	140	200	300	400	600
700 x 1000 mm	7410140C0002G				
1000 x 700 mm	27170C	27171C	27172C	27173C	27174C



GENYOUS® BLACK INTENSE

REBECCA Color

GenYous® Black Intense possède une teinte noire profonde, teintée dans la masse pour une intensité et une uniformité remarquable. Ce papier non couché allie une surface lisse d'exception à une excellente imprimabilité en numérique (toner sec / liquide) et en offset. Conçu à partir de fibres 100 % cellulose ECF, il est sans pigment carbone, résistant à la lumière, au blanchiment et sans migration. Sa main calibrée, son opacité et son toucher velouté en font une solution haut de gamme pour vos projets créatifs exigeants.

GenYous® Black Intense : une couleur affirmée, pour des créations qui marquent les esprits.

GenYous® Black Intense has a deep black, solution-dyed tint for remarkable intensity and uniformity. This uncoated paper combines an exceptionally smooth surface with excellent printability in both digital (dry / liquid toner) and offset printing. Made from 100 % ECF cellulose fibres, it is carbon pigment-free, lightfast, bleach-resistant and migration-free. Its calibrated bulk, opacity and velvety feel make it a top-of-the-range solution for your demanding creative projects.







GenYous® Black Intense: a bold colour for eye-catching creations.



111

REBECCA COLOR









GENYOU® BLACK INTENSE











	Ref.	Sizes (mm)	Gsm	Pallet Sizes (mm)	Stacks	Sheets / Pallet	Tabbed by	Pallet Net Weight (kg)
	7410140C0002G	700 x 1000	140g	720 x 1020	1	5 000	-	490
	27170C	1000 x 700	140g	720 x 1020	1	5 000	125	490
	27171C	1000 x 700	200g	720 x 1020	1	3 500	125	490
	27172C	1000 x 700	300g	720 x 1020	1	2 500	100	525
	27173C	1000 x 700	400g	720 x 1020	1	2 000	50	560
	27174C	1000 x 700	600g	720 x 1020	1	1 500	30	630

FICHE TECHNIQUE TECHNICAL DATA SHEET

	80	100	120	160	180	210	240	270	320
Thickness (µm)	107	134	157	209	232	271	310	348	413
Bulk (cm ³ /g)	1.34	1.34	1.31	1.31	1.29	1.29	1.29	1.29	1.29
Bendtsen roughness (W/F) (ml/min)	150	180	180	180	180	180	180	180	180
Absolute Humidity (%H ₂ O)	5.0	5.0	5.5	5.5	6.0	6.0	6.0	6.0	6.0
Relative Humidity (% in the air)	38	38	44	44	48	48	48	48	48

GAMME RANGE

Palletization	80				100		120		
	450x640		650x920	880x610	450x640		450x640		880x610
Pallet sizes (mm)	940x670 	960x690 	960x690 	900x640 	960x690 	940x670 	940x670 	960x690 	900x640 
Piles	2	2	1	1	2	2	2	2	1
Sheets/ pallet	20 000	20 000	12 500	12 500	16 000	16 000	14 000	14 000	8 500
Tabbed by	500	500	250	250	250	250	250	250	250
Ream weight (kg)	11,52	11,52	11,96	10,73	7,20	7,20	8,64	8,64	16,10
Pallet weight (kg)	461	461	598	536	461	461	484	484	547

Palletization	160		180	210	240	270	320			
	450x640		1000x700	450x640	450x640	700x1000	450x640	450x640	1000x700	
Pallet sizes (mm)	940x670 	960x690 	1040x720 	900x690 	940x670 	1050x750 	960x690 	960x690 	1040x720 	1040x720 
Piles	2	2	1	2	2	1	2	2	1	1
Sheets/ pallet	10 500	10 500	4 500	10 000	8 000	3 500	7 000	6 200	3 000	2 250
Tabbed by	250	250	125	125	125	125	100	100	100	75
Ream weight (kg)	11,52	11,52	14	6,48	7,56	18,37	6,91	7,77	18,90	16,80
Pallet weight (kg)	484	484	504	518	484	514	484	482	567	504

* Gammes disponibles à la rame, à l'unité
Ranges available per ream, per unit

Le papier peut être certifié PEFC ou FSC® selon la demande du client.
Paper can be PEFC or FSC® certified at the customer's request.



Coloris non Ecolabel :
Non-ecolabel colours:
intensive red / intensive pink / intensive lilac / royal blue /
intensive blue



TROPHÉE / PAPAGO

REBECCA Color

Créez, classez, faites partager une émotion.

Trophée offre une palette unique de teintes pastels ou intenses pour répondre à vos besoins et envies de création.

Couleurs chaudes, teintes délicates ou éclatantes, excellente résistance à la lumière et parfaite homogénéité de coloration, Trophée garantit une qualité irréprochable à vos documents.

Trophée est compatible avec les impressions offset et laser.

Trophée se décline dans une palette de 38 couleurs, 9 grammages de 80 à 320 g/m² dans des formats variés.

La gamme coordonnée A4/A3 est également disponible sur stock.

Create, classify, share an emotion.

Trophée offers a unique palette of pastel or intense shades to meet your creative needs and desires.















































Warm colours, delicate or bright shades, excellent resistance to light and perfect homogeneity of colouring, Trophée guarantees a lawless quality for your documents. Trophée is compatible with offset and laser printing.

Trophée is available in a palette of 38 colours, 9 substances from 80 to 320 gsm in various sizes.

The coordinated A4/A3 range is also available from mill stock.

























































































FULL PALLET (Delivery Unit = 1 pallet/item)

Colour	80g				100g		120g		
	450 x 640	650 x 920	880 x 610	450 x 640	450 x 640	880 x 610			
	 			 	 				
 Pearl Grey	9200	2043BC	2042C					2310C	
 Steel Grey	9500	2061BC					2112PC		
 Cream	2200	2023NBC	2023BC	2022C	3005C	3073BC	3073PC	2139BC 2139PC 2311C	
 Chamois	2500	2019NBC	2019BC	2018C	3004C		3021PC	2140PC 2312SC	
 Caramel	2800		3041BC		5380C			2141PC	
 Orange	4500		3024BC	3023C	3025C			2148PC	
 Abricot	4300		2064BC	2085C				2113PC	
 Peach	4400		2037BC						
 Gold	3800		2003BC	2002C				2142PC	
 Daffodil	3300		3029BC	3028C	3030C		3070PC	2157PC	
 Canary	3200	2027NBC	2027BC	2026C	3006C		3036PC	2063PC 2317C	
 Salmon	4100		2011BC	2010C				2143PC	
 Pink	5200		2015BC	2014C	3660C		3077PC	2057PC 2319C	
 Lilac	6200		2039BC		3009C			2144PC 2320C	
 Wild Rose	5400	2070NBC	2070BC					2114PC	
 Lavender	7500	2066NBC	2066BC						
 Dark Blue	7400		3014BC	3013C	3015C		3040PC	2145PC 2321C	
 Sky Blue	7300		3032BC	3033C	5360C			2146PC 2322SC	
 Blue	7100	2035NBC	2035BC	2034C	3008C		3074PC	2075PC 2323SC	
 Nature Green	8500		2004BC	2005C			2458PC	2073PC	
 Jade	8200		3019BC	3018C	3020C			2147PC	
 Green	8300	2031NBC	2031BC	2030C	3007C		3075PC	2084PC 2325SC	
 Pale Green	8100							2474BC	
 Flame	4700		2056BC		3050SC			2062PC	
 Intensive Orange	4900		2046BC		3045C			2136PC 2326C	
 Coral Red	5800		2054BC					2077PC	
 Intensive Red	5900	2050NBC	2050BC		3046C			2130PC 2327SC	
 Intensive Pink	5500		2049BC		3048C			2133PC 2328C	
 Intensive Lilac	6800		2053BC		3051C				
 Royal Blue	7800		2081BC					2178PC	
 Intensive Blue	7900	2051NBC	2051BC		3047C			2137PC 2330C	
 Intensive Yellow	3500	2048NBC	2048BC		3043C		3017PC	2134PC 2331C	
 Sunflower	3700		2082BC					2159PC	
 Intensive Green	8700		2047BC		3044C			2135PC 2332C	
 Billiard Green	8800		2058BC						
 Forest Green	8900		2052BC		3049C			2131PC	
 Black	9950							2459PC 2335C	
 Havana	2900		2566BC						

160g		180g		210g		240g		270g		320g		Colour
450 x 640	1000 x 700	450 x 640	1000 x 700	450 x 640	700 x 1000	450 x 640	1000 x 700	450 x 640	1000 x 700	1000 x 700		
9200	2041PC											Pearl Grey
9500	2116PC				1699BC							Steel Grey
2200	2149BC	2149PC	2535PC	2559PC	1664BC		2478PC	2494PC	1650CC	1651C		Cream
2500	2040PC						2479PC					Chamois
2800	2150PC											Caramel
4500	2044PC											Orange
4300	2117PC											Abricot
4400	2461PC											Peach
3800	2151PC											Gold
3300	2156PC		2557PC			2481PC	2496PC					Daffodil
3200	2069PC		2563PC	1666BC		2480PC				1662C		Canary
4100	2152PC											Salmon
5200	2060PC		2562PC	1698BC		2484PC				1674C		Pink
6200	2045PC											Lilac
5400	2118PC											Wild Rose
7500												Lavender
7400	2153PC		2564PC	1667BC		2487PC	2503PC			1690C		Dark Blue
7300	2154PC		2554PC			2486PC						Sky Blue
7100	2078PC											Blue
8500	2067PC		2467PC			2490PC	2505PC			1676C		Nature Green
8200	2155PC											Jade
8300	2087PC		2561PC	1693BC		2477PC						Green
8100	2475BC											Pale Green
4700	2059PC		2469PC			2492PC						Flame
4900	2095PC			1632BC								Intensive Orange
5800	2065PC											Coral Red
5900	2092PC	2539PC	2470PC	1636BC		2493PC						Intensive Red
5500	2089PC											Intensive Pink
6800	2086PC			1642BC								Intensive Lilac
7800	2158PSC											Royal Blue
7900	2083PC		2466PC	1640BC		2488PC						Intensive Blue
3500	2097PC		2463PC	1635BC		2482PC		1656CC	1677C			Intensive Yellow
3700	2462PC		2464PC			2483PC						Sunflower
8700	2096PC			1633BC								Intensive Green
8800	2115PC		2471PC	1649BC		2472PC						Billiard Green
8900	2080PC											Forest Green
9950	2460PC	2543PC			1647CC			1659CC				Black
2900	2569BC											Havana

MOQ: 1 individual ream

Colour		80g		100g	120g	160g	
		450 x 640 	650 x 920 	450 x 640 	450 x 640 	450 x 640 	1000 x 700 
	Pearl Grey	9200	2043RC	2042RC			2041RC
	Steel Grey	9500	2061RC			2112RC	2116RC
	Cream	2200	2023RC	2022RC	3073RC	2139RC	2149RC 2535RC
	Chamois	2500	2019RC	2018RC		2140RC	2040RC
	Caramel	2800	3041RC				2150RC
	Orange	4500	3024RC	3023RC		2148RC	2044RC
	Abricot	4300	2064RC	2085RC		2113RC	2117RC
	Peach	4400	2037RC				2461RC
	Gold	3800	2003RC	2002RC		2142RC	2151RC
	Daffodil	3300	3029RC	3028RC	3070RC	2157RC	2156RC
	Canary	3200	2027RC	2026RC	3036RC	2063RC	2069RC
	Salmon	4100	2011RC	2010RC		2143RC	2152RC
	Pink	5200	2015RC	2014RC	3077RC	2057RC	2060RC
	Lilac	6200	2039RC			2144RC	2045RC
	Violet	6500	2169RC				
	Wild Rose	5400	2070RC			2114RC	2118RC
	Lavender	7500	2066RC			2336RC	2345RC
	Dark Blue	7400	3014RC	3013RC	3040RC	2145RC	2153RC
	Sky Blue	7300	3032RC	3033RC		2146RC	2154RC
	Blue	7100	2035RC	2034RC	3074RC	2075RC	2078RC
	Nature Green	8500	2004RC	2005RC	2458RC	2073RC	2067RC
	Jade	8200	3019RC	3018RC		2147RC	2155RC
	Green	8300	2031RC	2030RC	3075RC	2084RC	2087RC
	Flame	4700	2056RC			2062RC	2059RC
	Intensive Orange	4900	2046RC			2136RC	2095RC
	Coral Red	5800	2054RC			2077RC	2065RC
	Intensive Red	5900	2050RC			2130RC	2092RC 2539RC
	Intensive Pink	5500	2049RC			2133RC	2089RC
	Intensive Lilac	6800	2053RC				2086RC
	Royal Blue	7800	2081RC			2178RC	2158RC
	Intensive Blue	7900	2051RC			2137RC	2083RC
	Intensive Yellow	3500	2048RC		3017RC	2134RC	2097RC
	Sunflower	3700	2082RC			2159RC	2462RC
	Intensive Green	8700	2047RC			2135RC	2096RC
	Billiard Green	8800	2058RC				2115RC
	Forest Green	8900	2052RC			2131RC	2080RC
	Black	9950				2459RC	2460RC 2543RC
	Havana	2900	2566RC				2569RC





	180g 450 x 640 	210g 700 x 1000 	240g 450 x 640 	270g 450 x 640 	1000 x 700 	Colour
9200						Pearl Grey 
9500						Steel Grey 
2200	2559RC		2478RC	2494RC	1650RC	Cream 
2500			2479RC			Chamois 
2800						Caramel 
4500						Orange 
4300						Abricot 
4400						Peach 
3800						Gold 
3300	2557RC		2481RC	2496RC		Daffodil 
3200	2563RC		2480RC			Canary 
4100						Salmon 
5200	2562RC		2484RC			Pink 
6200						Lilac 
6500						Violet 
5400						Wild Rose 
7500						Lavender 
7400	2564RC		2487RC	2503RC		Dark Blue 
7300	2554RC		2486RC			Sky Blue 
7100						Blue 
8500	2467RC		2490RC	2505RC		Nature Green 
8200						Jade 
8300	2561RC		2477RC			Green 
4700	2469RC		2492RC			Flame 
4900						Intensive Orange 
5800						Coral Red 
5900	2470RC		2493RC			Intensive Red 
5500						Intensive Pink 
6800						Intensive Lilac 
7800						Royal Blue 
7900	2466RC		2488RC			Intensive Blue 
3500	2463RC		2482RC		1656RC	Intensive Yellow 
3700	2464RC		2483RC			Sunflower 
8700						Intensive Green 
8800	2471RC		2472RC			Billiard Green 
8900						Forest Green 
9950		1647RC			1659RC	Black 
2900						Havana 

TROPHÉE NÉON

FICHE TECHNIQUE TECHNICAL DATA SHEET

	80	160	270
Thickness (µm)	107	209	348
Bulk (cm ³ /g)	1.34	1.31	1.29
Bendtsen roughness (W/F) (ml/min)	150	180	180
Absolute Humidity (%H ₂ O)	5.0	5.5	6.0
Relative Humidity (% in the air)	38	44	48

GAMME RANGE

Palletization	80		160	270
	450x640	1000x700	1000x700	1000x700
Pallet sizes (mm)	960x690  *	1040x720 	1040x720 	1040x720 
Piles	2	1	1	1
Sheets/ pallet	20 000	10 500	5 500	3 500
Tabbed by	500	250	125	100
Ream weight (kg)	11,52	11,96	11,96	16,15
Pallet weight (kg)	461	502	526	565

* Gamme disponible à la rame, à l'unité
Range available per ream, per unit

Le papier peut être certifié PEFC ou FSC® selon la demande du client.
Paper can be PEFC or FSC® certified at the customer's request.



Please collect used paper for recycling



TROPHÉE NÉON

REBECCA Color

Trophée Néon

Une résistance à la lumière éblouissante !

Jaune stimulant, Orange exubérant, Vert revigorant, Rose tonifiant...

Trophée Néon, c'est avant tout la symbiose parfaite entre des couleurs énergisantes et une solidité à la lumière optimale. Les teintes Néon gardent fraîcheur et éclat au fil des semaines, afin de répondre à votre volonté de marquer les esprits, d'opter pour une communication percutante ou d'organiser un rangement haut en couleur.

Trophée Néon, 4 papiers lumineux à mettre au centre de vos attentions.

Trophée Neon

Dazzling light resistance!

Stimulating Yellow, exuberant Orange, invigorating Green, refreshing Pink...









Trophée Neon is above all the perfect symbiosis between energising colours and optimal light fastness. Neon colours remain fresh and bright throughout the weeks, to meet your desire to make a lasting impression, to opt for a striking communication or to organise a colourful storage.

















Trophée Neon, 4 luminous papers to put at the centre of your attention.







TROPHÉE NÉON





FULL PALLET (Delivery Unit = 1 pallet/item)

Colour		80g		160g	270g
		450 x 640 	1000 x 700 	1000 x 700 	1000 x 700 
 Fluo Pink	5000	2074BC	2405C	2415C	2434C
 Fluo Yellow	3000	2072BC	2408C	2418C	2435C
 Fluo Green	8000	2055BC	2411C	2419C	2474C
 Fluo Orange	4000	2068BC	2412C	2433C	2475C

	Ref.	Sizes (mm)	Gsm	Pallet Sizes (mm)	Stacks	Sheets / Pallet	Tabbed by	Pallet Net Weight (kg)
	2074BC	450 x 640	80g	960 x 690	2	20 000	500	461
	2072BC	450 x 640	80g	960 x 690	2	20 000	500	461
	2055BC	450 x 640	80g	960 x 690	2	20 000	500	461
	2068BC	450 x 640	80g	960 x 690	2	20 000	500	461
	2405C	1000 x 700	80g	1040 x 720	1	10 500	250	502
	2408C	1000 x 700	80g	1040 x 720	1	10 500	250	502
	2411C	1000 x 700	80g	1040 x 720	1	10 500	250	502
	2412C	1000 x 700	80g	1040 x 720	1	10 500	250	502
	2415C	1000 x 700	160g	1040 x 720	1	5 500	125	526
	2418C	1000 x 700	160g	1040 x 720	1	5 500	125	526
	2419C	1000 x 700	160g	1040 x 720	1	5 500	125	526
	2433C	1000 x 700	160g	1040 x 720	1	5 500	125	526
	2434C	1000 x 700	270g	1040 x 720	1	3 500	100	565
	2435C	1000 x 700	270g	1040 x 720	1	3 500	100	565
	2474C	1000 x 700	270g	1040 x 720	1	3 500	100	565
	2475C	1000 x 700	270g	1040 x 720	1	3 500	100	565

TROPHÉE NÉON

Colour	80g	450 x 640
 Fluo Pink	5000	2074RC
 Fluo Yellow	3000	2072RC
 Fluo Green	8000	2055RC
 Fluo Orange	4000	2068RC

Ref.	Sizes (mm)	Gsm	Pallet Sizes (mm)	Stacks	Sheets / Pallet	Tabbed by	Pallet Net Weight (kg)
 2074RC	450 x 640	80g	960 x 690	2	20 000	500	461
 2072RC	450 x 640	80g	960 x 690	2	20 000	500	461
 2055RC	450 x 640	80g	960 x 690	2	20 000	500	461
 2068RC	450 x 640	80g	960 x 690	2	20 000	500	461

FICHE TECHNIQUE TECHNICAL DATA SHEET

	65	80	120	160
Thickness (µm)	81	100	150	200
Bulk (cm³/g)	1.25	1.25	1.25	1.25
Bendtsen roughness (W/F) (ml/min)	230	230	230	230
Absolute Humidity (%H2O)	5.5	5.5	5.5	5.5

GAMME RANGE

Palletization	65		80				120	160
Pallet sizes (mm)	430 x 610	650 x 920	430 x 610	450 x 640	650 x 920	700 x 1000	650 x 920	650 x 920
Sheets/ pallet	22 000	11 000	20 000	20 000	10 000	10 000	7 000	4 500
Tabbed by	500	500	500	500	250	250	250	100
Pallet weight (kg)	374	428	420	460	478	560	503	431



www.blauer-engel.de/uz14a



The mark of responsible forestry



Please collect used paper for recycling



ROUGHNESS

BENGALI

REBECCA Color

La couleur est un vecteur unique de communication. Utilisez là pour créer, classer, partager une émotion.

Vous pouvez désormais le faire avec Bengali, une gamme créative produite à partir de 100% de fibres de récupération. Ses couleurs vives, son aptitude à l'impression laser et offset en font le support idéal d'une communication verte, ou jaune, ou fuchsia ou orange...

Le choix est vaste parmi ses 17 couleurs et 4 grammages.

Colour is a unique vector of communication. Use it to create, classify, share an emotion.

You can do it from now on with Bengali, a creative range produced from 100% recovered fibres.

























Its bright colours, its ability to laser and offset printing make it the ideal medium for a green, or yellow, or fuchsia or orange coloured communication....

The choice is wide among its 17 shades and 4 substances.



BENGALI

100% RECYCLED Papers

Colour	65g				80g				
	430 x 610		650 x 920		430 x 610		450 x 640		
									
 Bright Blue	BLE13		50119RC	50119RBC	50120RC	50120RBC	50029RC	50029RBC	
 Dark Blue	BLE08						50032RC	50032RBC	
 Lemon	JAU01	50140RC	50140RBC	50142RC	50142RBC	50143RC	50143RBC	50006RC	50006RBC
 Yellow	JAU02	50134RC	50134RBC	50136RC	50136RBC	50137RC	50137RBC	50034RC	50034RBC
 Ivory	JAU05							50042RC	50042RBC
 Butter Cup	JAU13					50126RC	50126RBC		
 Tangerine	ORA08					50153RC	50153RBC	50047RC	50047RBC
 Salmon	ORA17							50020RC	50020RBC
 Red	ROU01							50018RC	50018RBC
 Fuchsia	ROU02					50180RC	50180RBC	50011RC	50011RBC
 Raspberry	ROU06					50174RC	50174RBC		
 Light Pink	ROU16							50015RC	50015RBC
 Coral Pink	ROU17	50164RC	50164RBC	50166RC	50166RBC	50167RC	50167RBC	50009RC	50009RBC
 Light Green	VER01	50157RC	50157RBC	50158RC	50158RBC	50159RC	50159RBC	50052RC	50052RBC
 Lime	VER03					50403RC	50403RBC	50022RC	50022RBC
 May Green	VER19							50024RC	50024RBC
 Lilac	VIO04							50044RC	50044RBC

BENGALI

100% RECYCLED Papers

	80g				120g		160g		Colour
	650 x 920		700 x 1000		650 x 920		650 x 920		
BLE13	50030RC	50030RBC	50031RC	50031RBC	50073RC	50073RBC	50085RC	50085RBC	Bright Blue
BLE08	50033RC	50033RBC					50132RC	50132RBC	Dark Blue
JAU01	50037RC	50037RBC	50038RC	50038RBC	50075RC	50075RBC	50087RC	50087RBC	Lemon
JAU02	50035RC	50035RBC					50086RC	50086RBC	Canary
JAU05	50043RC	50043RBC			50076RC	50076RBC			Ivory
JAU13	50005RC	50005RBC							Butter Cup
ORA08	50048RC	50048RBC	50049RC	50049RBC	50077RC	50077RBC	50089RC	50089RBC	Tangerine
ORA17	50246RC	50246RBC							Salmon
ROU01	50019RC	50019RBC							Red
ROU02									Fuchsia
ROU06	50175RC	50175RBC					50178RC	50178RBC	Raspberry
ROU16	50016RC	50016RBC	50017RC	50017RBC					Light Pink
ROU17	50010RC	50010RBC					50170RC	50170RBC	Coral Pink
VER01	50053RC	50053RBC					50090RC	50090RBC	Light Green
VER03	50023RC	50023RBC					50358RC	50358RBC	Lime
VER19	50025RC	50025RBC			50083RC	50083RBC			May Green
VIO04	50046RC	50046RBC							Lilac

SPIRIT_{of} PAPER®

2

05/2026

Parce qu'il est un acteur historique du marché.
Parce qu'il maîtrise de A à Z toutes les étapes de production, transformation et livraison.
Parce qu'il dispose d'une capacité d'invention technique pour répondre rapidement à toutes les demandes, Clairefontaine propose des gammes de papiers pour la chaîne graphique.

Clairefontaine, c'est d'abord une marque emblématique et son logo – la Verseuse Rebecca.

C'est aussi un siècle et demi d'une connaissance filiale et intime du papier qui a forgé des produits devenus des classiques. Qu'il s'agisse du cahier d'écolier au toucher iconique ou de la rame Clairalfa qui accompagne avec exigence notre environnement de bureau.

Clairefontaine c'est tout cela : un savoir-faire français, une histoire, une audace.

Mieux. Clairefontaine c'est une certaine idée, un certain esprit du papier.

Ce Spirit of Paper prend pour nom Rebecca. Qu'elles soient Rock, Sublim ou Life, les gammes Rebecca affirment toute l'autorité Clairefontaine dans la maîtrise des papiers offset haut de gamme.

Because we are a historic leading player in the market.

Because we master all the stages of production, converting and delivery from A to Z.

Because we have the technical invention capacity to meet quickly all requests, Clairefontaine offers several ranges of papers for the graphic chain.

Clairefontaine is first of all an emblematic brand with its logo Rebecca. Our intimate knowledge of paper of a century and a half has forged products which have become best sellers.

Whether it is the exercise book with its iconic touch or the Clairalfa ream which accompanies our office environment, Clairefontaine is all this : French know-how, a history and audaciousness!

Even more. Clairefontaine is a certain idea, a certain spirit of paper.

This Spirit of Paper has taken the name Rebecca. Whether they are named Rock, Sublim or Life, the Rebecca ranges assert all the Clairefontaine authority in the mastery of top-of-the-range offset papers.



Papeteries de Clairefontaine
F - 88480 Etival Clairefontaine
Tel. +33 (0)3 29 42 42 42

info@clairefontaine.eu - www.clairefontaine.eu

Follow us on LinkedIn 